

ENVIROMUX® Series

E-16D/-5D/-2D
Enterprise Environment Monitoring System
Installation and Operation Manual



Front and Rear View of E-16D



Front View of E-5D



Front View of E-2D



TRADEMARK

ENVIROMUX and the NTI logo are registered trademarks of Network Technologies Inc in the U.S. and other countries. All other brand names and trademarks or registered trademarks are the property of their respective owners.

COPYRIGHT

Copyright © 2005-2026 by Network Technologies Inc. All rights reserved. No part of this publication may be reproduced, stored in a retrieval system, or transmitted, in any form or by any means, electronic, mechanical, photocopying, recording, or otherwise, without the prior written consent of Network Technologies Inc, 1275 Danner Drive, Aurora, Ohio 44202.

CHANGES

The material in this guide is for information only and is subject to change without notice. Network Technologies Inc reserves the right to make changes in the product design without reservation and without notification to its users.

CE Statement

We, Network Technologies Inc, declare under our sole responsibility that the E-16D , E-5D and E-2D are in conformity with European Standard EN55022.

Firmware Version

Current Firmware version 4.37

As of firmware version 2.35, the webserver in the E-xD supports only TLS v1.2 security encryption. Due to security vulnerability, SSL is no longer supported.

Electrical

E-16D: 100-240VAC, 50-60Hz, 1.5A@110VAC/0.75A@230VAC

E-5D: 100 to 240 VAC at 50 or 60 Hz via AC adapter; 1.7A@9VDC (9VDC 3A power supply included)

E-2D: 100 to 240 VAC at 50 or 60 Hz via AC adapter; 1.1A@9VDC (9VDC 3A power supply included)



WARNING

The E-16D contains a sealed lead acid battery. Battery maintenance must be performed by an authorized trained technician. Always follow local laws and regulations regarding the disposal of this unit.

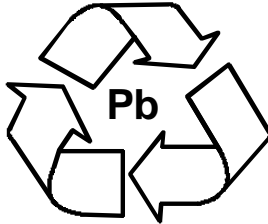
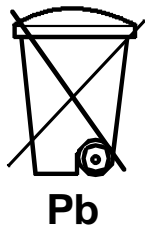

CAUTION

Turn OFF power to the ENVIROMUX and discharge your body's static electric charge by touching a grounded surface or use a grounding wrist strap before performing any connections to the unit.

For continued protection against fire and electric shock this device should only be connected to an AC mains outlet equipped with a proper ground terminal.

The ENVIROMUX is NOT intended to be used as a primary security, fire or smoke communication or control system.

All topics listed below are covered throughout this manual, but for instruction that focuses on specific topics, the following is available to you. Click on the Manual # to view the subject.

ENVIROMUX E-xD Supplemental Instructions

MANUAL #	Description
SMAN154-01	How to setup Email
SMAN154-02	How to setup and test SMS messaging
SMAN154-03	How to setup Syslog
SMAN154-04	How to create x509 certificate
SMAN154-05	How to setup SNMP <ul style="list-style-type: none"> ➤ SMS relay via SNMP ➤ SNMP- locating OIDs ➤ SNMP- use with DCIM ➤ SNMP-acquire CPU-memory usage data ➤ SNMP-read values with Paessler PRTG ➤ SNMP-use to configure settings ➤ SNMP-use to control siren or beacon ➤ SNMP-using Intermapper with the ExD ➤ Open Source Monitoring Integration
SMAN154-06	How to use Modbus TCP/IP support to enable PLC controls to read the value/state of some sensors
SMAN154-07	How to use JSON API to poll sensors using HTTP protocol
SMAN154-08	Using enable-disable global alerts feature
SMAN154-09	How to shutdown windows server using remote SSH command
SMAN154-10	ENVIROMUX Battery Replacement Instruction
SMAN154-11	How to setup Cascading Configuration of ENVIROMUXs
SMAN154-12	How to setup Smart Alerts in an ENVIROMUX
SMAN154-13	How to setup MQTT Communication

TABLE OF CONTENTS

Introduction.....	1
Materials	4
Supported Web Browsers	5
Features And Functions	6
Installation	8
Mounting Instructions-16D.....	8
Mounting Instructions-5D / -2D.....	9
DIN Rail Mounting.....	10
Sensor Attachment	11
RJ45 Sensor Ports.....	11
Digital In Terminals	12
Liquid Detection Sensors.....	12
Alarm(Beacon/Siren) Connections	14
Connect Output Devices.....	15
Terminal Connection for RS232	16
Ethernet Connection for Remote User Control.....	17
Modem Connection.....	18
USB GSM Modem	18
SMS Relay Via SNMP	19
SMS via User Configuration	19
Power Connection-E-16D	20
Dual Power Option.....	20
DC Power Option	21
Power Connection- E-5D/-2D	21
Remote RS232 Device Control.....	23
Overview - Use And Operation.....	25
Sensors	25
IP Assignment.....	25
User Management	25
Alerts.....	25
Data and Event Logging	26
Email	26
Syslog	26
SNMP.....	26
SNMP Sensors	26
Modbus TCP/IP Support.....	26
External Modem.....	26
Power-on/Reset Operation	26
Out-of-Box Operation.....	27
Expandability.....	27
Device Discovery Tool.....	28
How to Use the Device Discovery Tool	28
Use and Operation via Web Interface	29

Log In and Enter Password	29
Alternative initial page.....	30
Monitoring	31
Summary Page	31
Power Supplies	33
Power Supply Alert Configuration	33
Alarm Summary	36
Internal Sensors.....	37
External Sensors.....	38
External Sensor Configuration	43
Specialized Sensors (for E-S420MA-24V Current Sensor Configuration only).....	49
Contact Sensors	51
Monitor Output Relay	57
IP Devices.....	59
IP Sensors	63
SNMP Sensors	66
IP Cameras	69
Administration	72
System Configuration	72
Administration-Enterprise Setup	77
Administration-Network Setup	81
User Configuration	92
Maps Config.....	99
Group Names.....	101
Security	102
Using a RADIUS Server	104
System Information.....	109
Administration- Firmware	110
Reboot the System	111
Log.....	112
View Event Log	112
View Data Log.....	113
View USB Data Log	114
View USB Event Log	115
View USB Images.....	115
Log Settings	116
Support	119
Logout.....	119
Front Panel Controls and LED Indicators.....	120
System Reset Button	120
Alarm Test/Silence Button	121
Restore Defaults Button.....	121
Battery Backup	121
E-16D	121
E-5DB / -2DB	121
USB Port.....	122
Serial Control.....	122

Mobile Summary Page	123
E-16D Specifications	124
Front Panel Interface	124
RJ45 Sensor Inputs	124
Digital Inputs	124
Output Relays	124
Beacon Port & Siren Port.....	124
USB Device Ports	125
Control Serial Port “RS232”	125
USB-Serial Port “Console”	125
Auxiliary Power Port	125
Ethernet Port.....	125
Back-Up Battery.....	125
General Specifications.....	125
TCP/IP	125
E-5D Specifications	126
User Interface	126
RJ45 Sensor Inputs	126
Digital Inputs	126
Output Relays	126
Alarm Port.....	126
USB Device Ports	126
USB-Serial Port “Console”	127
Auxiliary Power Port	127
Ethernet Port.....	127
General Specifications.....	127
TCP/IP	127
Optional Battery	127
E-2D Specifications	128
User Interface	128
RJ45 Sensor Inputs	128
Digital Inputs	128
Output Relays.....	128
USB Device Ports	128
USB-Serial Port “Console”	128
Auxiliary Power Port	129
Ethernet Port.....	129
General Specifications.....	129
TCP/IP	129
Optional Battery	129
Port Assignments	130
DDNS Provider List	130
Wiring Methods	131
RS485 Sensor Cable	131
Contact Sensor Wiring.....	131
Troubleshooting.....	132
RS485 Sensors	135

Bandwidth Usage	136
Index.....	137
Warranty Information	138

TABLE OF FIGURES

Figure 1- Secure rack mount ears to E-16D	8
Figure 2- Mount ENVIROMUX in a rack	8
Figure 3- Rotate the tabs for Zero-RU mounting.....	9
Figure 4- Mount E-5D/2D in a rack	9
Figure 5- Mount E-5D/2D to DIN rail- plastic clip	10
Figure 6- DIN Rail Mount with metal clip.....	10
Figure 7- Sensors connected by cables with RJ45 connectors.....	11
Figure 8- Contact sensor wired to RJ45 socket	11
Figure 9- DIGITAL IN Terminal Connections	12
Figure 10- Secure liquid detection sensor with tape	13
Figure 11- Portion of Water Sensor configuration page.....	13
Figure 12- Connect visual and audible external indicators.....	14
Figure 13- Install additional devices to output terminals	15
Figure 14- Connect a terminal for direct RS232 serial communication	16
Figure 15- Connect a terminal using USB Console port	16
Figure 16- Connect ENVIROMUX to the Ethernet	17
Figure 17- E-2D-POE with PoE Switch	17
Figure 18- Install USB GSM Modem.....	18
Figure 19- Connect the power cord	20
Figure 20- Power connections for ENVIROMUX with Dual Power Option	20
Figure 21- 48VDC Power Option Connections	21
Figure 22- Connect the AC adapter and power-up	21
Figure 23- Power connections on E-5D-48VDP.....	22
Figure 24- Power Supply sensors-Summary Page	22
Figure 25- Connect serially controlled device	23
Figure 26- Create user "rs232"	23
Figure 27- Connection to serial device successful.....	24
Figure 28- Device Discovery Tool.....	28
Figure 29- Login prompt to access web interface	29
Figure 30- Summary page	30
Figure 31- Alternative initial page in Web Interface	30
Figure 32- Summary Page.....	32
Figure 33- Power Supply status- Dual Power model	33
Figure 34- Power Supply alerts configuration-part 1.....	33
Figure 35- Power Supply alerts configuration-part 2.....	34
Figure 36- Alarm Summary Page	36
Figure 37- Internal Sensor Configuration.....	37
Figure 38- External Sensor Reading.....	39
Figure 39- Sensor Configuration Page (1)	40
Figure 40- Sensor Configuration Page (2)	41
Figure 41- Sensor Configuration Page (3)	42
Figure 42- Sensor Configuration Page (4)	43
Figure 43- Chart to setup alert notification.....	45
Figure 44- Schedule Settings for alerts.....	47
Figure 45- Colored blocks indicate variations in settings	47

Figure 46- Disable alerts for an entire day	48
Figure 47- Disable alerts for the same hour every day	48
Figure 48- Select 15 minute increments of control over alerts	48
Figure 49- Current sensor added to ENVIROMUX	49
Figure 50- Configuration of sensor connected to E-S420MA-24V	49
Figure 51- List of sensors	51
Figure 52- Add a contact sensor	51
Figure 53- Contact Sensor configuration page	52
Figure 54- Contact and Digital Alert Settings	53
Figure 55- Digital Input Sensors	54
Figure 56- Select connector on ENVIROMUX	54
Figure 57- Configure New Sensor	55
Figure 58- Status of Digital Input #2	55
Figure 59- Open configuration from Digital Input page	55
Figure 60- Connection that supports Tachometer Sensor	56
Figure 61- Monitoring Output Relays	57
Figure 62- Output Relay Status	57
Figure 63- Output Relay Contact State	57
Figure 64- Configure Output Relay	58
Figure 65- IP Devices monitored	59
Figure 66- Add new IP Device	59
Figure 67- IP Device Configuration.....	60
Figure 68- IP Device Configuration-more.....	61
Figure 69- Add IP Sensor	63
Figure 70- IP Sensor List	64
Figure 71- IP Sensor Settings for Temperature and Dewpoint	65
Figure 72- PWR-RMT-RBT-C13 Sensors List	65
Figure 73- SNMP Sensor status on Summary Page.....	66
Figure 74- SNMP Sensor page.....	66
Figure 75- SNMP Sensor Configuration page.....	67
Figure 76- Events page under Smart Alerts.....	68
Figure 77- Event settings for SNMP Sensor being monitored.....	68
Figure 78- Monitoring IP Cameras.....	69
Figure 79- IP Camera Configuration	70
Figure 80- Cameras requiring authentication.....	71
Figure 81- Camera access login	71
Figure 82- Camera feed after login	71
Figure 83- System Configuration page	72
Figure 84- Configuration Backup and Restore.....	73
Figure 85- Configure the purpose of the "RS232 AUX" port	74
Figure 86- System Configuration-continued.....	75
Figure 87- Sensor Settings	76
Figure 88- Enterprise Configuration Page.....	77
Figure 89- GSM Modem Status	78
Figure 90- GSM Modem Error Alert Configuration.....	78
Figure 91- Example of Plain Text SMS Test Message.....	79
Figure 92- Button for Printing Modem status to the Event Log	79
Figure 93- SMS Relay Configuration	80
Figure 94- Network Configuration Page.....	81
Figure 95- Apply IPv4 or IPv6 Settings	81
Figure 96- Configure SMTP, SNMP, and security settings	82
Figure 97- SMTP Settings- Gmail	84
Figure 98- Office 365 server settings- before authorization	85

Figure 99- Office 365 server settings- after authorization	85
Figure 100- Configure MQTT and Server Settings	86
Figure 101- Configure 3G/4G Data Connection.....	88
Figure 102- DDNS Settings	90
Figure 103- Disable Legacy Management Software	90
Figure 104- How to setup SNMP to control output relays	91
Figure 105- Usernames List and Status.....	92
Figure 106- Edit user profile for root user	92
Figure 107- More user settings	93
Figure 108- Schedule Settings for users.....	95
Figure 109- Colored blocks indicate variations in settings	95
Figure 110- Disable messages for an entire day	96
Figure 111- Disable messages for the same hour every day.....	96
Figure 112- Select 15 minute increments of control over messages	96
Figure 113- More user settings	97
Figure 114- Summary page for User without Admin privileges	98
Figure 115- Maps Configuration page.....	99
Figure 116- View from Administration menu	100
Figure 117- View from Monitoring menu	100
Figure 118- Sensors on map in different states	101
Figure 119- Enter custom group names.....	101
Figure 120- Security Configuration page	102
Figure 121- Dictionary file of RADIUS server.....	104
Figure 122- User Password Restrictions.....	106
Figure 123- Security Configuration-X509 Certificate.....	107
Figure 124- Security Configuration- IP Filtering Rules	108
Figure 125- System Information page.....	109
Figure 126- Update Firmware Page.....	110
Figure 127- Reboot System page	111
Figure 128- System is rebooting	111
Figure 129- Event Log page	112
Figure 130- Data Log page	113
Figure 131- View Saved USB Data Log.....	114
Figure 132- View Saved USB Event Log	115
Figure 133- View Images saved on USB Flash Drive	116
Figure 134- Log Settings page.....	117
Figure 135- Mount a USB Flash Drive	118
Figure 136- Steps to unmount a flashdrive	118
Figure 137- Support.....	119
Figure 138- Logout	119
Figure 139- Front panel	120
Figure 140- USB Flash Drive/Modem/LCD Monitor port.....	122
Figure 141- Mobile Login page	123
Figure 142- Mobile Summary page.....	123

INTRODUCTION

The ENVIROMUX Enterprise Environment Monitoring System (ENVIROMUX) provides a way to supervise, from a remote location, the environmental conditions and security in cabinets and rooms containing servers, hubs, switches and other network components. Input data is filtered, collected, analyzed and processed to instantly and accurately display the status of the room. The user is able to specify parameters for all monitored conditions: if the parameters are exceeded, the unit will signal an alarm, which may include several pre-defined processes.

The E-16D, our most feature-filled model, includes sensors that monitor the internal temperature and humidity of the unit, giving readings that can be used as an estimate for the conditions of other nearby rack components.

All models are capable of monitoring external RS485 sensors and additional digital contact-type sensors (often called open-collector, contact-closure, relay-style, normal-open, or normal-closed). All sensors are sold separately, available from NTI. ENVIROMUX includes output relays to control devices such as door locks, keypads, and circulation fans. The E-16D and E-5D also include outputs specifically for the connection of an alarm siren and/or beacon.

The external sensors sold by NTI will monitor temperature and humidity, monitor AC line voltage, frequency, and current, detect smoke, and much more. The temperature and humidity sensors will provide current readings as well as alerts when thresholds are exceeded. The AC line monitor detects AC line input voltages between 50~250V AC, the Frequency (Hertz) between 47~63Hz, and the Power (Current) up to 12 amperes from a single AC line. The remainder of the sensors will simply provide alerts. These sensors can be manufactured by any third party, provided the alert notification method is compatible. Each of the aforementioned NTI sensors will connect to the ENVIROMUX via RJ45 connectors and CAT5 cable.

The ENVIROMUX can also work with both 4-wire and 2-wire contact-style sensors (4-wire sensors require a power connection, 2-wire do not). An external power supply for some 4-wire sensors may be required (sold separately). Screw terminals are provided for the connection of external contact-style sensors.

The Ethernet provides the main user interface for the ENVIROMUX. The ENVIROMUX provides data logging that can be viewed via a web browser and send alerts via email, Syslog, SNMP traps, SMS text messages and front panel LEDs. USB ports are provided for the connection of a USB modem and for downloading log data to a USB flash drive.

Features: (see Feature Differences chart on next page for more details)

- Multiplatform support: Windows 7/8/10/11, Windows Server 2008/2012/2016/2019/2022, Linux, FreeBSD, and MAC OS 10/11/12.
- Enables up to 16 users to monitor environmental conditions and security status remotely
- Alerts users of environmental faults via email, Syslog, SMS messages, SNMP traps (v1, v2c, and/or v3), Illuminated front panel LEDs, or notifications on a web page
- Sensors are assigned to organized groups, and users can receive alerts from any group(s)
- Smart alerts provide sophisticated configurable multi-event triggering of alert messages or device control
- Up to 16 users can control simultaneously via Ethernet and a single user control serially via connected terminal
 - Connections include RJ45 and USB for local serial control
 - RJ45 w/ LEDs for Ethernet-based control
- Easy connections for sensors and devices
 - RJ45 connections w/o LEDs provided for sensors
 - Screw terminals for digital input devices and digital output devices
- 12VDC provided for all digital inputs (E-16D only)
- RJ45 Sensors include Temperature, Humidity, Temperature and Humidity, Water, Vibration, Smoke, Motion Sensor, Glass break detector and many more
- Provides control for devices such as door locks, keypad, or a fan via digital outputs (1A/ 30VDC, .5A/ 100VAC)
- Full configuration via web-based graphic user interface
- Limited configuration using text menus via Telnet , SSH, RS232 or USB-to-serial interface
- Browser independent (IE, Chrome, Mozilla, Opera)
- Outgoing mail using SMTP or SMTP over TLS for alert notifications- up to 16 different email addresses
- Configurable Alarms to match specific user schedule
- Local Email Authentication, TLS
- Data logging to keep viewable record of events such as changes in the environment or user access
- Monitor (ping) up to 64 configurable IP addresses. Response Timeout and number of retries are user configurable for each address
- Flash firmware upgradeable via FTP server or web page
- USB ports for USB modem and USB flash drive
- Internal temperature, humidity, and power sensors (E-16D, 5DB, 2DB (see chart on next page)

A. Internal Temperature Sensor

- For monitoring the temperature inside the E-16D/5D case.
 - Use an external temperature sensor for monitoring ambient air temperature.
- Applications from 32 to 104°F (0 to 40°C).
- Accurate to within ±1.44°F (±0.80°C) for 32 to 41°F (0 to 5°C), and
- Accurate to within ±0.72°F (±0.40°C) for 41 to 104°F (5 to 40°C)

B. Internal Humidity Sensor

- For monitoring the humidity inside the E-16D/5D case.
 - Use an external humidity sensor for monitoring humidity in the air.
- Applications from 20% to 80% relative humidity at temperatures between 32 to 104°F (0 to 40°C).
- Accurate to within ±3% relative humidity.

C. Internal Power Sensor

- Measures mains voltage: 0 to 255 VAC
- Measures battery voltage: 0 to 20 VDC
- Measures voltage on 24VDC models: 20 to 32VDC
- Measures voltage on 48VDC models: 36 to 72VDC
- Alerts are sent when there is a power outage and when power returns.

The E-5D Medium Enterprise Environment Monitoring System and E-2D Small Enterprise Environment Monitoring System have almost the same functionality as the E-16D, just fewer connection points.

**E-16D vs. E-5D vs. E-2D
Feature Differences**

Feature	E-16D	E-5D	E-2D
Internal Sensors	3	2	0
Temperature	✓	✓	N/A
Humidity	✓	✓	N/A
Battery	✓	only for E-5DB	only for E-2DB
RJ45 Sensor Ports	16	5	2
Digital Inputs	8	5	5
12VDC provided on Digital Inputs	✓	N/A	N/A
Output Relays	4	2	1
Auxiliary (12V) Power Terminal	✓	✓	✓
Alerts	8 Methods	8 Methods	6 Methods
Alarm Silence/Test Button	✓	✓	N/A
Control Methods	6 Methods	6 Methods	5 Methods**
USB Ports for Modem and Data Logging	4	4	2
Front Panel LEDs	6	2	2
Backup Battery	✓ (1 Hour)	Optional (2 Hour) (E-5DB)	Optional (2 Hour) (E-2DB)
Power	<ul style="list-style-type: none"> • 110 or 220 VAC at 50 or 60 Hz via IEC connector. 65W • Options: dual power, 18-36VDC, 36-72VDC, 18-36VDC dual power, 36-72VDC dual power 	110 or 220 VAC at 50 or 60 Hz via AC adapter. 3A Optional Dual Power, 18-72VDC, 18-72VDC dual power	110 or 220 VAC at 50 or 60 Hz via AC adapter / 3A Optional Dual Power Optional PoE support

* No dedicated alarm beacon/siren terminals although they CAN be connected to E-2D

** E-2D does not include an RS232 port for console control, but a USB Type B “Console” port (and drivers) is provided for this control method.

N/A= Not Available

Options:

- **E-16D**
 - **Dual Power** – ENVIROMUX with two power connections for optional redundant power source connection (see page 20) - add "DP" to the model number (i.e. E-16DDP)
 - **DC Power** - to install the ENVIROMUX in a Telecom environment (see page 21). Add "-48V" or "-24V" to the model number (i.e. E-16D-48V). A "48V" model ENVIROMUX accepts 36-72VDC while a "24V" model accepts 18-36VDC, positive or negative polarity and includes a 3-pole screw terminal for connecting the DC voltage input.
 - **Extended Logging**- To increase the Data log capacity from 1724 to 1,200,000, and the Event log capacity from 1000 to 3000, add "EL" to the model number (i.e. E-16DEL).
- **E-5D /-2D**
 - **DIN Rail Mounting**- E-5D or -2D can be ordered with a DIN rail mounting bracket- Add "D" to the part number (i.e. E-5D-D)
 - **Battery Backup**- E-5D or -2D can be ordered with battery backup support and DC power monitoring installed, providing up to 2.3 hours of operation in the event of a power failure- to order, add "B" to the part number (i.e. E-5DB)
 - **48V/24V Power Option**- E-5D-48V can be ordered with power connections for 18-72VDC (24 or 48VDC nominal).
 - E-2D-24V can be ordered with power connections for 9-36VDC (24VDC nominal).
 - **POE Option**- E-2D-POE includes built-in Power over Ethernet (PoE) (supports IEEE 802.3af (PoE) and 802.3at (PoE+) standards.) Auxiliary power jack not included. AC adapter **is** included.
 - Proprietary schemes such as Cisco Discovery Protocol are not supported.
 - **48VINDLT Industrial Low Temperature Option**- E-5D-48VINDLT will operate between 36-72VDC at temperatures between -40 to 185°F (-40 to 85°C)

MATERIALS

Materials included with the E-16D kit:

- E-16D Large Enterprise Environment Monitoring System
- Power Cord- country specific (2 power cords for model E-16DDP)(**excluded in E-16D-48V/24V**)
- 1-CB4306 USB2-AB-6-5T 2 meter USB 2.0 male type A-male type-B transparent cable
- CT6182 DB9 Female-to-RJ45 Female adapter
- 1- CB7339 5 foot RJ45-to-RJ45 CAT5 SF patch cable
- Rack mount kit

Materials included with the E-5D kit:

- NTI E-5D Medium Enterprise Environment Monitoring System
- 1- PS4225 120VAC or 240VAC at 50 or 60Hz-9VDC/3A AC Adapter (**excluded in E-5D-48V(DP)**)
-OR-
1- PS4264 120VAC or 240VAC at 50 or 60Hz-9VDC/5A AC Adapter (**E-5D(B)-IND only**)
- 1- Line cord- country specific (**excluded in E-5D-48V(DP)**)
- 1- CB4306 USB2-AB-2M-5T 2 meter USB 2.0 male type A-male type-B transparent cable
- 1- CT6182 DB9 Female-to-RJ45 Female adapter
- 1- CB7339 5 foot RJ45-to-RJ45 CAT5 SF patch cable

Materials included with the E-2D kit:

- NTI E-2D Small Enterprise Environment Monitoring System
- 1- PS4225 120VAC or 240VAC at 50 or 60Hz-9VDC/3A AC Adapter (**excluded in E-2D-24V**)
- 1- Line cord- country specific (**excluded in E-2D-24V**)
- 1- CB4306 USB2-AB-2M-5T 2 meter USB 2.0 male type A-male type-B transparent cable

Materials required for connection but not supplied:

- Cables required for connection:
 - Cat5 for RS485 sensors with RJ45 connectors wired to the TIA/EIA-568B standard (see page 131 for specifications)
 - E-2W-xx 2-wire sensor cables for dry contact sensors
- Cable required for Ethernet connection:
 - Cat5 cable with RJ45 connectors wired straight through (pin 1 to pin 1, pin 2 to pin 2, etc..)
- E-TRMPLG Terminating Plug- one required if multiple E-16D units will be cascaded using the RS485 connection method (see [cascaded configuration](#) instruction)

See our webpage for the latest sensors available; <http://www.networktechinc.com/environment-monitor-16d.html>

Contact your nearest NTI distributor or NTI directly for all of your cable needs at 800-RGB-TECH (800-742-8324) in US & Canada or 330-562-7070 (Worldwide) or at our website at www.networktechinc.com and we will be happy to be of assistance.

SUPPORTED WEB BROWSERS

Most modern web browsers should be supported. The following browsers have been tested:

- Microsoft Edge
- Mozilla FireFox 1.5 or higher
- Opera 9.0
- Google Chrome

Note: If HTTPS pages cannot be viewed in the browser (“The page cannot be displayed” message appears) try to disable SSL 2.0 and TLS 1.0 from advanced options of the browser.

As of firmware version 2.35, the webservice in the E-xD supports only TLS v1.2 security encryption. Due to security vulnerability, SSL is no longer supported.

FEATURES AND FUNCTIONS

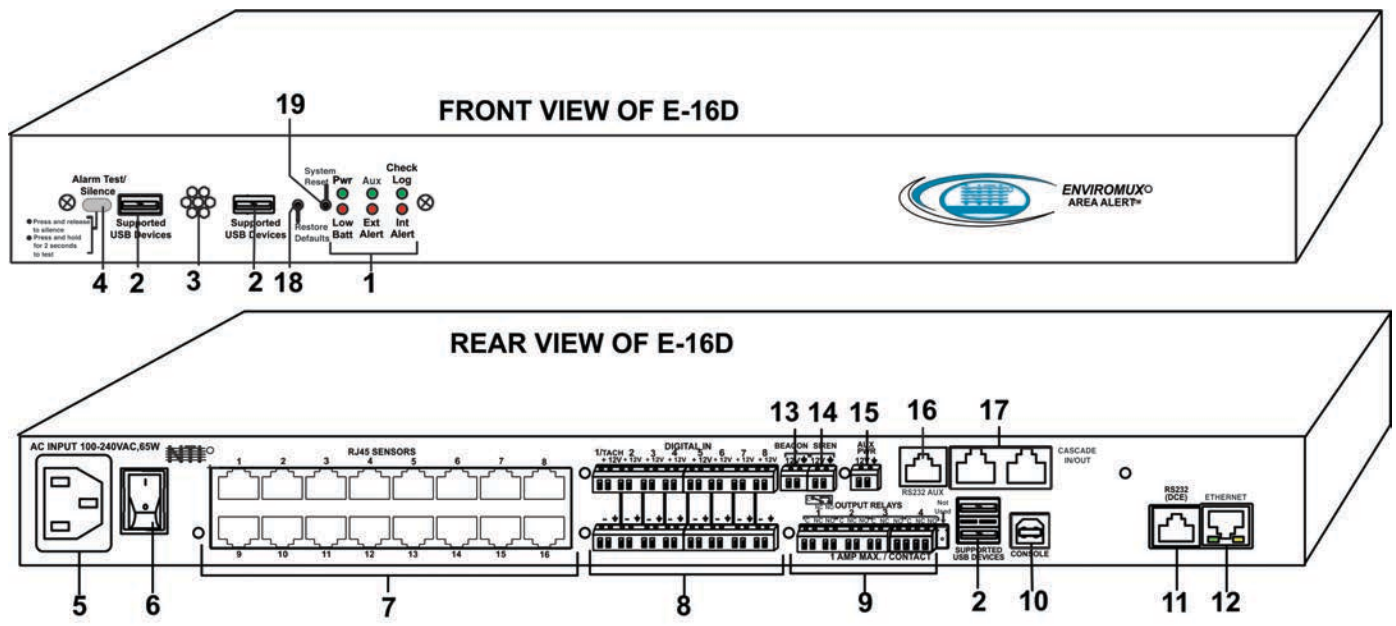

#	LABEL (LEDs)	DESCRIPTION
1	Pwr-	indicates when power to ENVIROMUX is ON (solid ON) and when power failure has occurred (battery power is ON- LED is blinking once per second)
	Low Batt-	indicates that the backup battery is running low on power, disconnected, or in failure
	Check Log-	illuminates when a new entry that is not an alert is added to the log
	Int Alert-	illuminates when an internal sensor generates an alert
	Ext Alert-	illuminates when an external sensor generates an alert
	Aux-	Not used as of this printing
	Fault-	red — illuminates if a sensor goes out of range of a configurable threshold (E-2D/5D Only)

See LED Status Chart (page 120) for more on LED indicators.

#	LABEL	CONNECTOR	DESCRIPTION
2	Supported USB Devices	USB Type A Female	for connection of supported USB 1.1 compatible devices (USB modem or flash drive for logging data)(see more information on pages 18 and 122)
3	None	None	Opening for humidity sensor to sense
4	Alarm Test/Silence	Button	Used to test or silence the alarm connected to the siren terminals
5	---	IEC Connector	for connecting the power cable (see also "Dual Power Option" on page 20)
6	---	Power Switch	used to turn the power to the ENVIROMUX ON/OFF
7	RJ45 Sensors	RJ45 female connectors	for attachment of various sensors
8	Digital IN	Terminal block	connection block for wired sensors (2-to-4 wire)
9	Output Relays	Terminal block	connection block for devices to be controlled in the event of alerts
10	Console	USB Type B female connector	For connecting USB cable for serial connection of a terminal to control the system
11	RS232 (DCE)	RJ45 female connector	Alternative port for RS232 serial connection of a terminal to control the system
12	Ethernet	RJ45 female connectors	for connection to a Local Area Network (LAN) for remote configuration, monitoring, and control
13	Beacon	Terminal block	for two-wire connection of visual indication of alarm (page 14)
14	Siren	Terminal block	for two-wire connections of audible indication of alarm (page 14)

#	LABEL	CONNECTOR	DESCRIPTION
15	Aux Pwr	Terminal block	for powering an auxiliary device with 12VDC power at 150mA maximum (fuse protected)
16	RS232 AUX	RJ45 female	for connection of a remote RS232 device to be controlled
17	Cascade In / Out	RJ45 female connectors	used for RS485 method of cascading multiple E-16D units
18	Restore Defaults	Reset Button	for manually restoring the ENVIROMUX back to factory settings (see page 120 for details)
19	System Reset	Reset Button	for manually resetting the system (rebooting) the ENVIROMUX (see page 120 for details)
20	9V 3A- PWR1	2.1x5.5mm Power Jack	for connection of primary power supply (not present in E-2D-POE)
20a	9V 3A- PWR2	2.1x5.5mm Power Jack	for connection of backup power supply

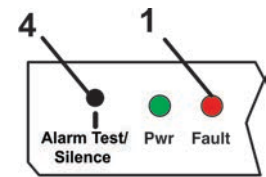
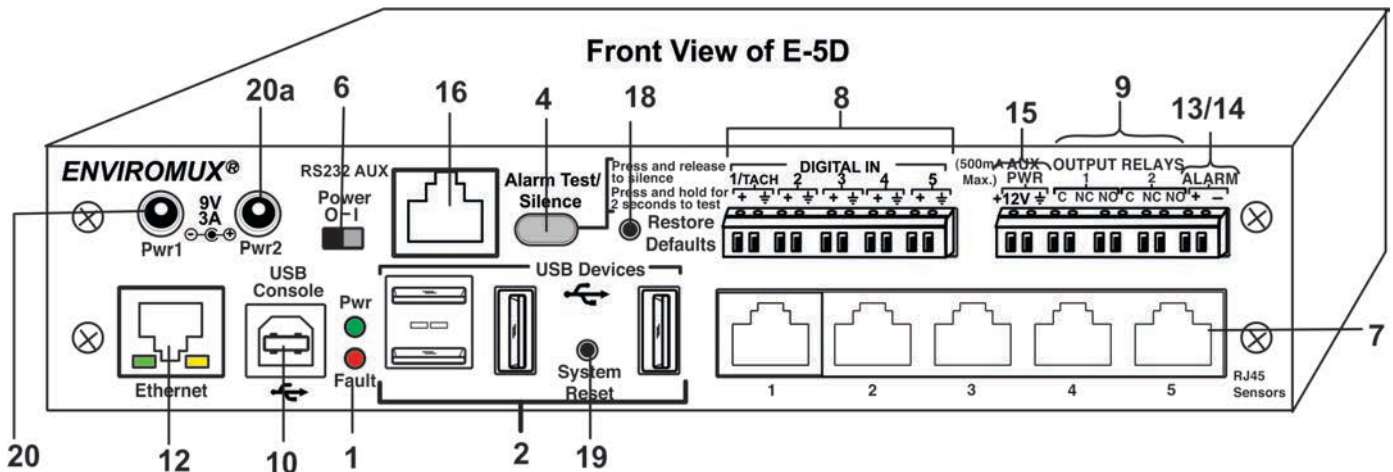

E-5D REAR VIEW

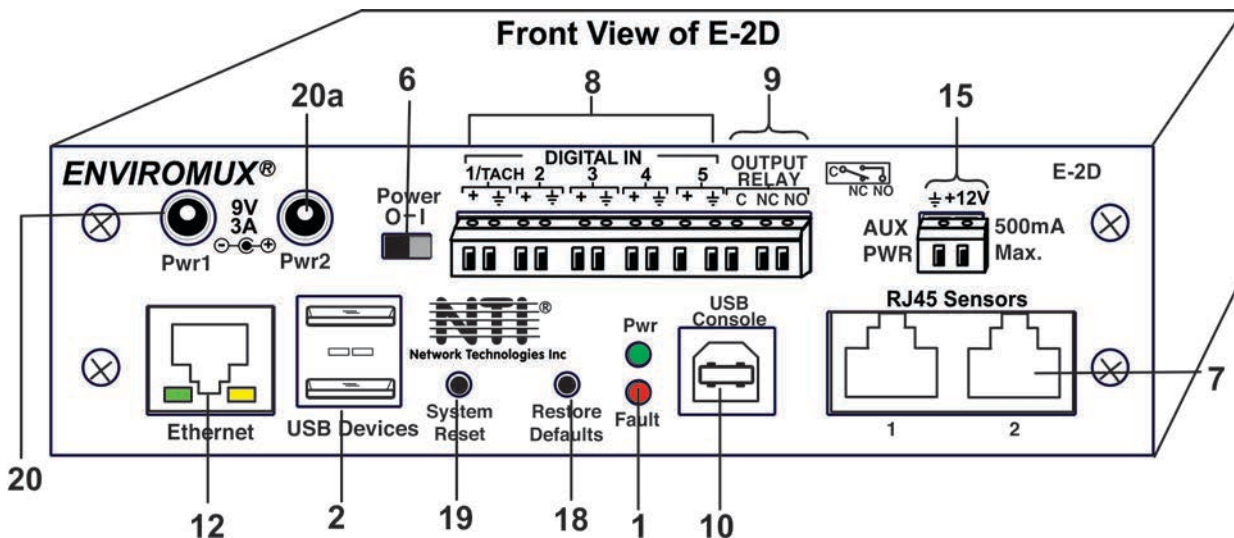

INSTALLATION

Mounting Instructions-16D

The E-16D was designed to either sit on a shelf or be mounted in a rack. For mounting in a rack It includes a rack mount kit to make attachment easy.

1. Attach the ears to the ENVIROMUX using the #6-32x3/16" flat Phillips-head screws (6) provided as shown in the illustration below.

FYI: The same hole pattern is provided at the front and rear of the ENVIROMUX, enabling the ENVIROMUX to be mounted with the front facing out or rear facing out.

2. The holes in the ears should line up with pre-threaded holes in the sides of the ENVIROMUX. Tighten the screws securely.

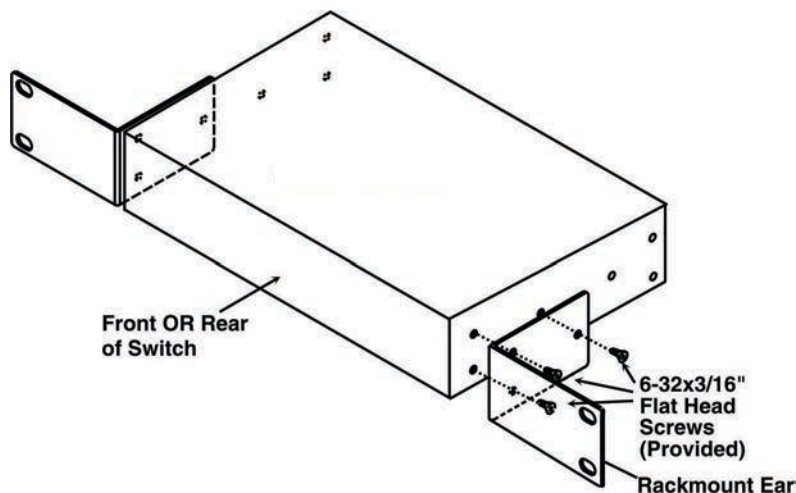

Figure 1- Secure rack mount ears to E-16D

3. Install 4 cage nuts to the rack in locations that line up with the holes in the mounting ears on the ENVIROMUX.
4. Secure the ENVIROMUX to the rack using four #10-32x3/4" screws and cage nuts (provided). Be sure to tighten all mounting screws securely.

Note: Do not block power supply vents in the ENVIROMUX case. Be sure to enable adequate airflow in front of and behind the ENVIROMUX.

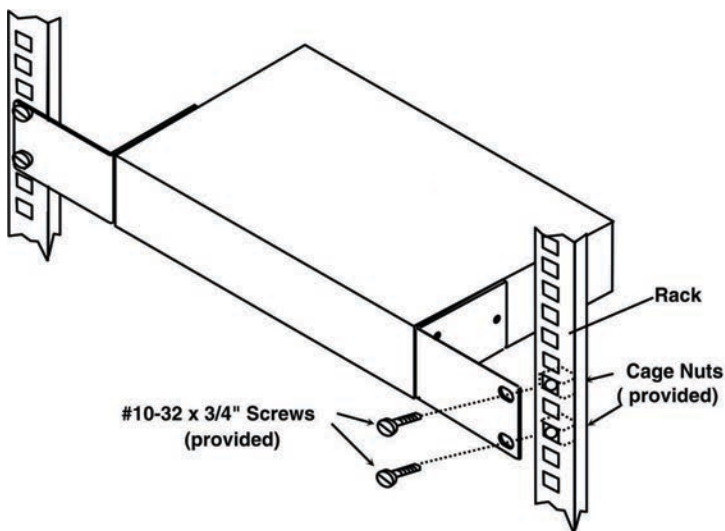

Figure 2- Mount ENVIROMUX in a rack

5. Attach all cables securely to the ENVIROMUX and where necessary supply adequate means of strain relief for cables.

Mounting Instructions-5D / -2D

The E-5D and -2D can either be placed on a solid surface, mounted to a wall, mounted to a DIN rail or mounted to an accessible surface within rack (Zero-RU). To mount to a wall or other surface, first remove the screws holding the mounting tabs to the rear of the box. Rotate the tabs such that they extend from the back of the box, and attach the tabs with the screws removed. Now the ENVIROMUX can be secured to any convenient surface. Use appropriate hardware (not supplied) when mounting.

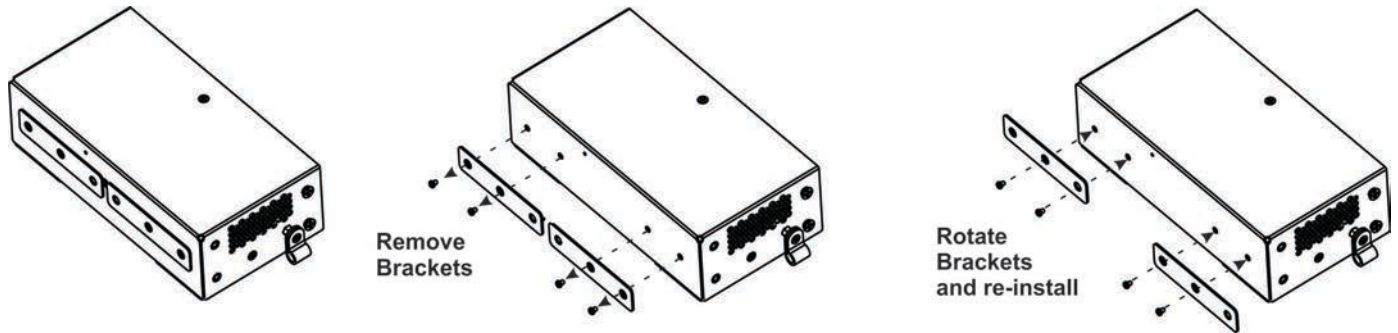

Figure 3- Rotate the tabs for Zero-RU mounting

If rack-mounting is preferred, the E-RK1-5D or E-RK1-2D rack-mount kit can be used (sold separately). Simply attach the ears (instructions included with the kit) and secure to a rack with the hardware provided.

FYI: Two sets of mounting holes are provided on the side of the ENVIROMUX to enable the ears to be attached such that the ENVIROMUX can be mounted with the front facing out or rear facing out, as desired.

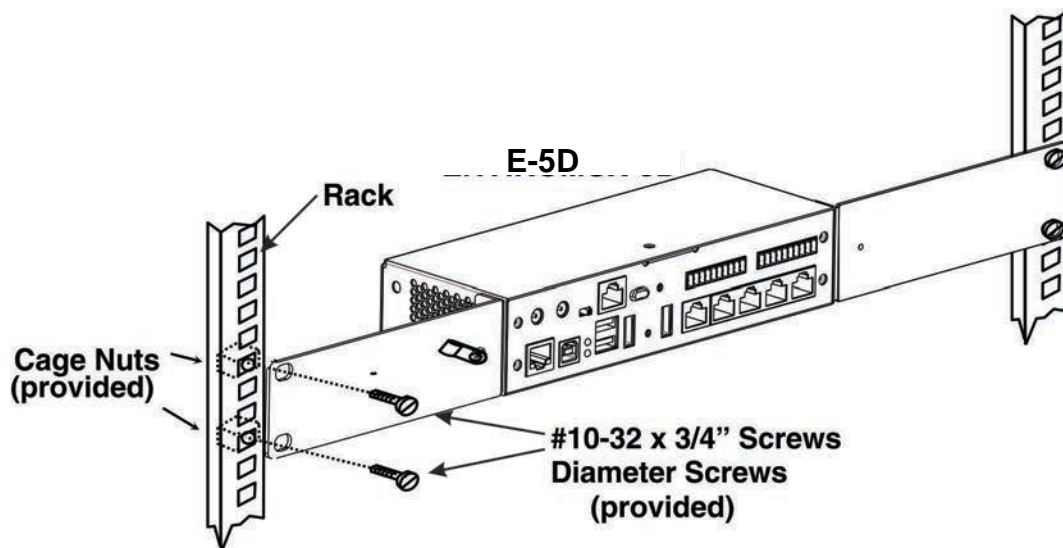

Figure 4- Mount E-5D/2D in a rack

DIN Rail Mounting

If DIN rail mounting is preferred, and you have purchased the E-5D-D or E-2D-D, then a DIN rail bracket has been pre-installed on the ENVIROMUX. Simply determine where on the DIN rail you want to place the ENVIROMUX and follow the instructions below for attaching it.

Note: You will either have a plastic DIN rail clip or a metal one. Instruction for each is provided below.

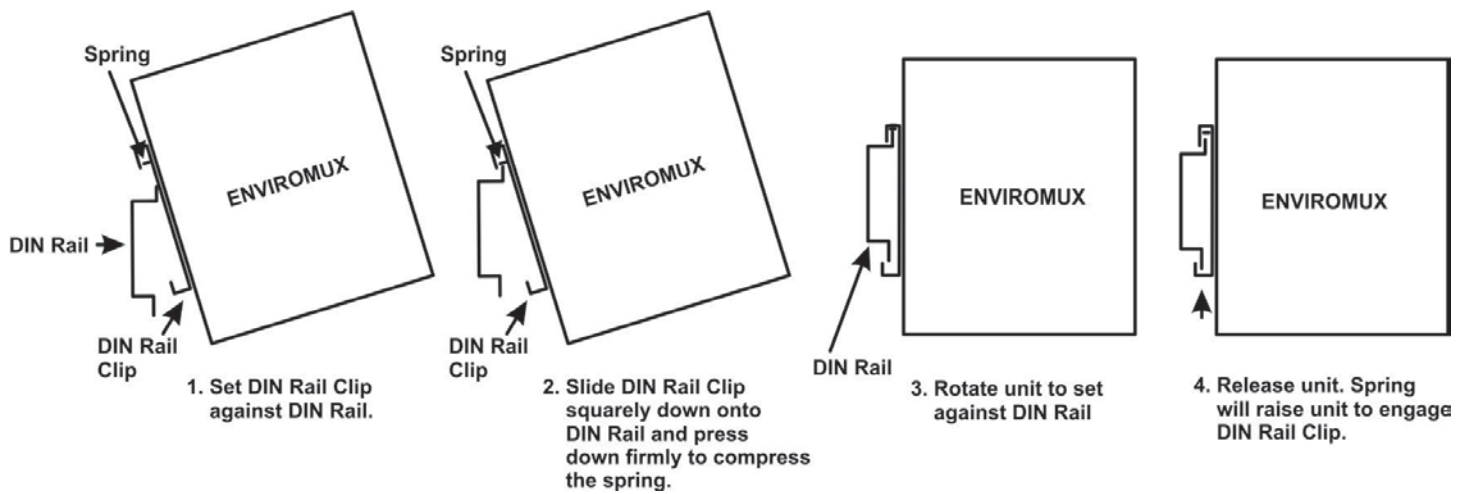

Figure 5- Mount E-5D/2D to DIN rail- plastic clip

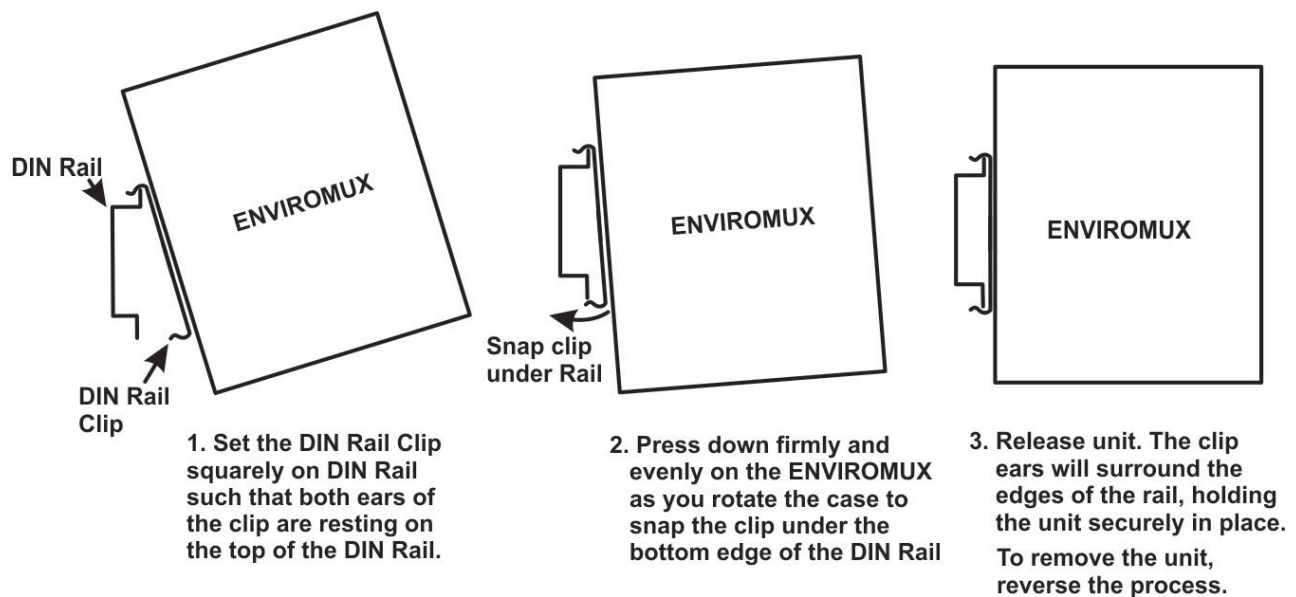

Figure 6- DIN Rail Mount with metal clip

Sensor Attachment

Connect the desired sensors (sold separately) to the available ports on the ENVIROMUX. Sensors come with one of two connection methods, RJ45 and individual wires for terminal connection. This section explains both methods of connection. Configuration of these sensors will come later in this manual.

RJ45 Sensor Ports

1. Connect each external sensor having an RJ45 male connector on it (E-ST5, E-STHSB, E-LDS) to one of the female connectors labeled "RJ45 Sensors" on the ENVIROMUX. Male connectors should snap into place. Cables may be up to 1000 feet in length. See page 131 for wiring specification and pinout.

Note: It is very important to locate the temperature and/or humidity sensors away from ventilation sources and fans.

If CATx cabling will be installed near sources of EMI (electric motors, light ballasts, etc) use shielded cable to reduce the introduction of noise to the circuits. Otherwise, communications between the sensor and ENVIROMUX may be unreliable.

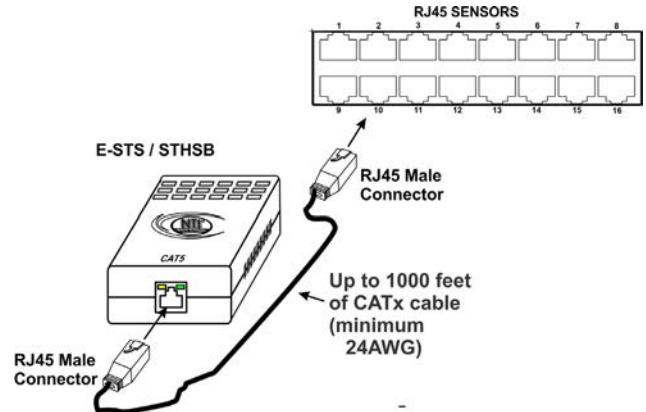

Figure 7- Connected by cables with RJ45 connectors

The RJ45 SENSORS ports can be used to connect a variety of sensors. Specifically on the E-16D, the combined power load of all 12VDC sensors on each row of ports (ports 1-8 is one row and ports 9-16 is the second) **cannot exceed 500mA per row**. Some sensors use more power than others. The table below provides the top power users:

Sensor	12VDC Power Consumption in mA	Sensor	12VDC Power Consumption in mA
E-S420MA-24V	130	E-ACLM-V	70
E-ACLM-P	130	E-S5VDC(-5V)	100
E-EDR-SF	200		

Caution: Be careful not to overload the E-16D as failure may occur and damage to the ENVIROMUX may result.

2. Some sensors do not have RJ45 connectors on them and instead have terminal blocks. These can either be connected to the "DIGITAL IN" connectors or they can be terminated and plugged into the remaining RJ45 connectors (see figure-right). (The illustration uses CAT5 patch cable to make cable connection easy.) Some examples of these sensors include E-IMD, E-IMD-CM, E-VSS, E-SDS, and E-GBS. Cables may be up to 1000 feet in length.

Note: For sensors requiring 5VDC power source, connect the wht/brown wire to pin 4 instead of pin 7.

All contact sensors can be wired in this way and use the RJ45 sensor ports instead of the Digital In terminals if desired.

Schematic for wiring Contact Sensor to RJ45 Socket

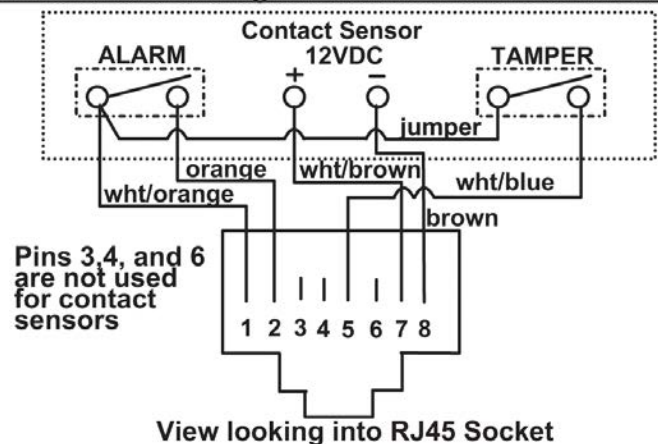

Figure 8- Contact sensor wired to RJ45 socket

Digital In Terminals

To connect contact sensors without using RJ45 connectors, terminal blocks have been provided labeled "DIGITAL IN". Two wire switch-only type sensors can be connected to the DIGITAL IN terminals as shown below. If the sensors require a 12V power source to operate, additional 12V and ground terminals have been provided on each model, with restrictions as shown. Connect each two-wire or four-wire contact sensor using 16-26 AWG wire.

FYI: The terminal block is removable for easy sensor wire attachment if needed.

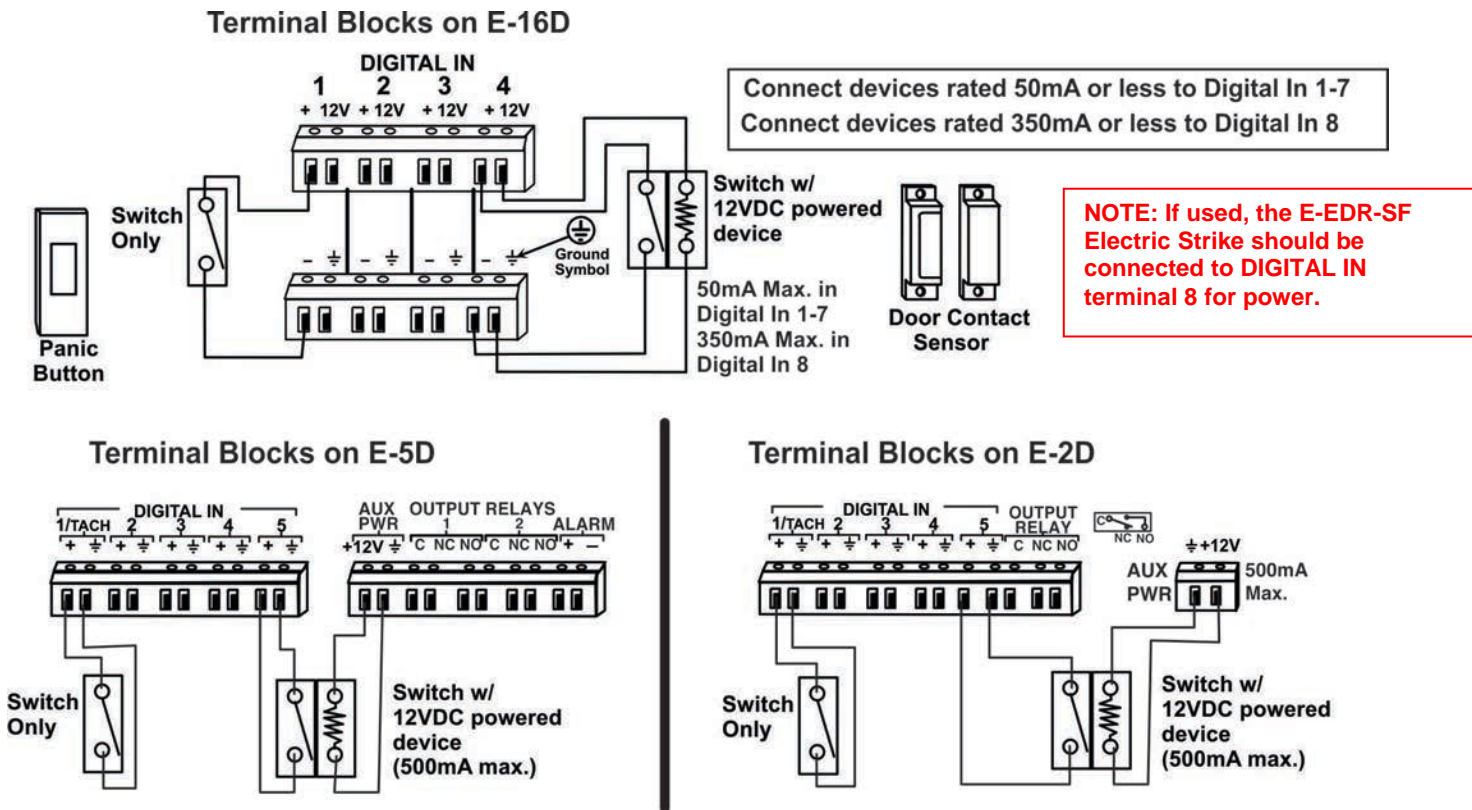

Figure 9- DIGITAL IN Terminal Connections

Liquid Detection Sensors

Liquid Detection Sensors are available for simple connection to either the "Digital In" terminals (use model E-LD) or the "RJ45 Sensor" ports (use model E-LDS).

Connect the two-wire cable (up to 1000 feet long) from a liquid detection sensor (E-LD shown in Figure 10-upper image) to a set of "DIGITAL IN" contacts. For added range (up to 1000 more feet), use an E-LDS (shown in Figure 10-lower image) and connect to an "RJ45 Sensor" port.

Note: If you are not looking to extend a liquid detection sensor (E-LDx-y) an additional 1000 feet, you can still connect the two-wire cable to pins 1 and 2 of the RJ45 connector (Figure 8) and plug it into an RJ45 Sensor Port instead of connecting it to a Digital In terminal. You do not have to use an E-LDS for the sensor to work, only to extend it an additional 1000 feet.

The twisted orange sensing cable should be placed flat on the surface (usually the floor) where liquid detection is desired. If tape is required to hold the sensor in place, be sure to only apply tape to the ends, exposing as much of the sensor as possible. At least 5/8" of the sensor must be exposed for it to function. (See Figure 10)

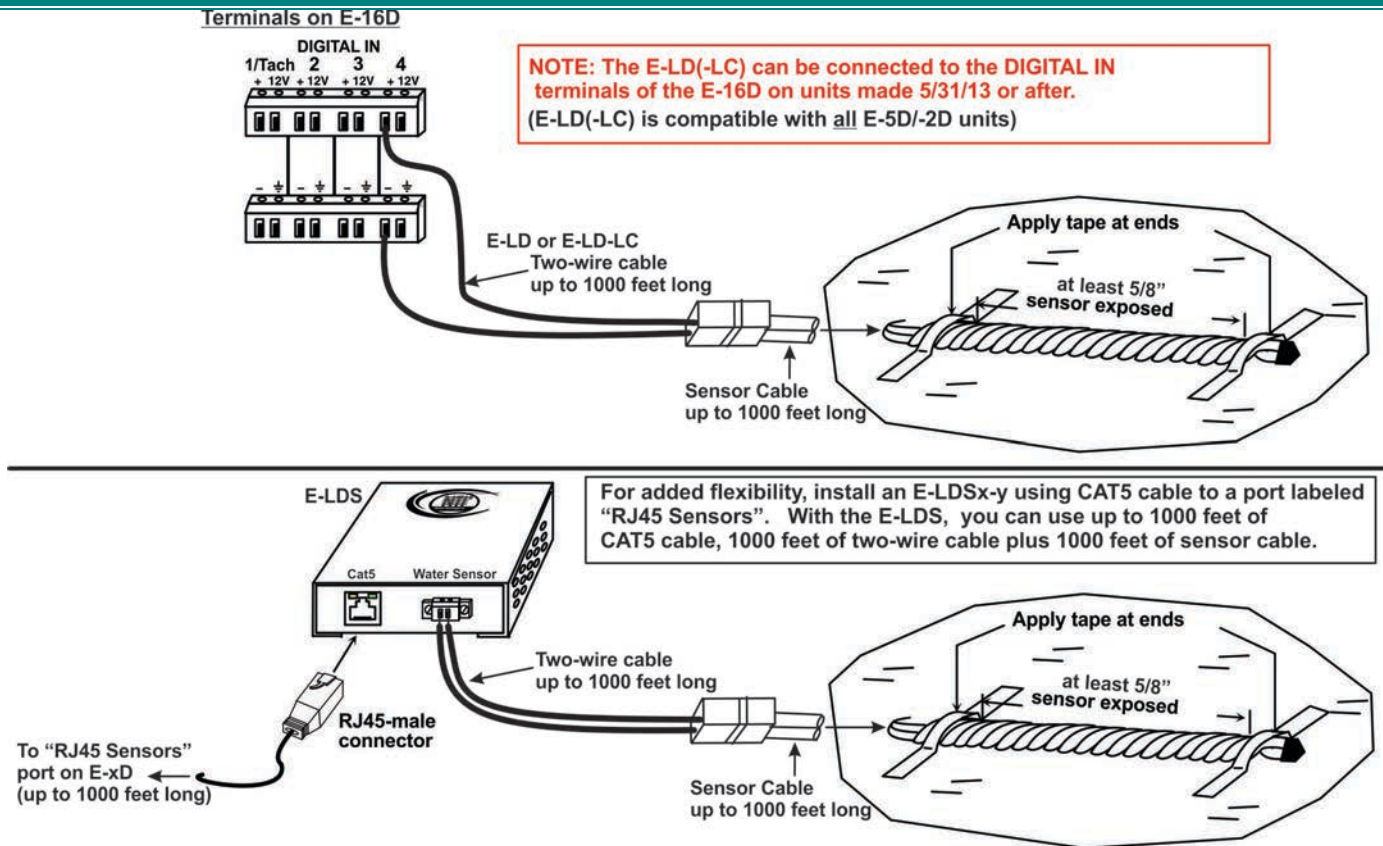

Figure 10- Secure liquid detection sensor with tape

After installation of rope style leak detection sensor in its desired location, **it is very important** to test the sensor to verify correct installation. This applies to **all** rope-style leak detection sensors (E-LD/ E-LD-LC / E-CD, etc.).

To test the rope style leak detection sensor;

1. Configure the sensor (page 51). (Normal Status set to “Open”, Sampling Period set to 5 seconds.)
2. Place approximately one table spoon of tap water across the sense cable so that the 2 thin sensing wires are connected by mutual contact with the water. Do NOT use distilled water as water must be conductive.
3. Monitor the sensor (page 31) to see the sensor “Value” change from “Open” (dry) to “Closed” (wet). (How quickly the change occurs is based on the amount of impurities in the water, so allow up to 30 seconds).
4. Dry the exposed area of the sensor and the sensor “Value” should change back to “Open” within 30 seconds.

If the sensor fails to behave in this manner, contact NTI for support.

This completes the testing of the sensor.

New Sensor Configuration

Digital Input Settings	
Description	Water Sensor <small>Descriptive name for the digital input</small>
Group	1 <small>Select which group the digital input belongs to</small>
Normal Status	Open <small>Select the normal status for the digital input</small>
Refresh Rate	5 Sec <small>The refresh rate at which the digital input view is updated</small>

Figure 11- Portion of Water Sensor configuration page

Alarm(Beacon/Siren) Connections

Terminals have been provided for connection of the E-BCN-R Beacon and E-SRN-M Siren to use for visual alerts and audible alerts when configured. Devices such as this can be installed in locations best suited to get attention. The terminals for these connections will accept 16-26 AWG wire.

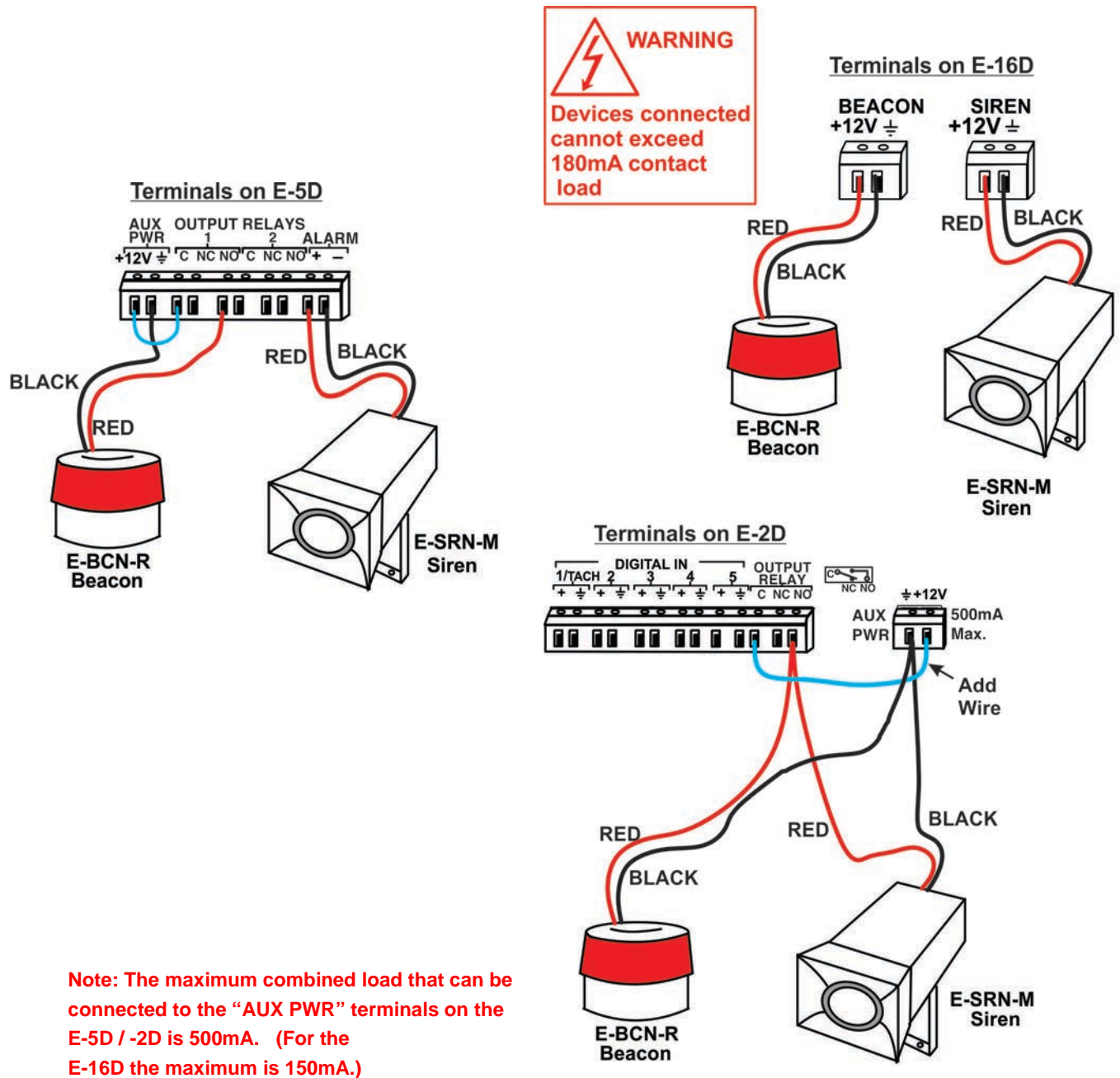

Figure 12- Connect visual and audible external indicators

Connect Output Devices

For connection of additional output devices to be controlled by the ENVIROMUX, terminals labeled "Output Relays" have been provided. The contacts will work as switches to either close or open circuits (switch ON or OFF) when used. The "default" position of the switch is configurable independently (page 57) and how the switch reacts to sensor alerts can also be configured on any Sensor Configuration page (page 39).

The status page and any sensor configuration page describe the Output Relay's status as either "active" or "inactive".

- When a relay is "active", the circuit will be closed between the **Normally Open** and **Common** contacts of the relay.
- When a relay is "inactive", the circuit will be closed between the **Normally Closed** and **Common** contacts of the relay.



WARNING OUTPUT RELAY dry contact ratings must not be exceeded. Dry contact rating: DC 30V or AC 125V, 1A. The OUTPUT RELAY contacts are not to be connected directly to AC mains wiring.

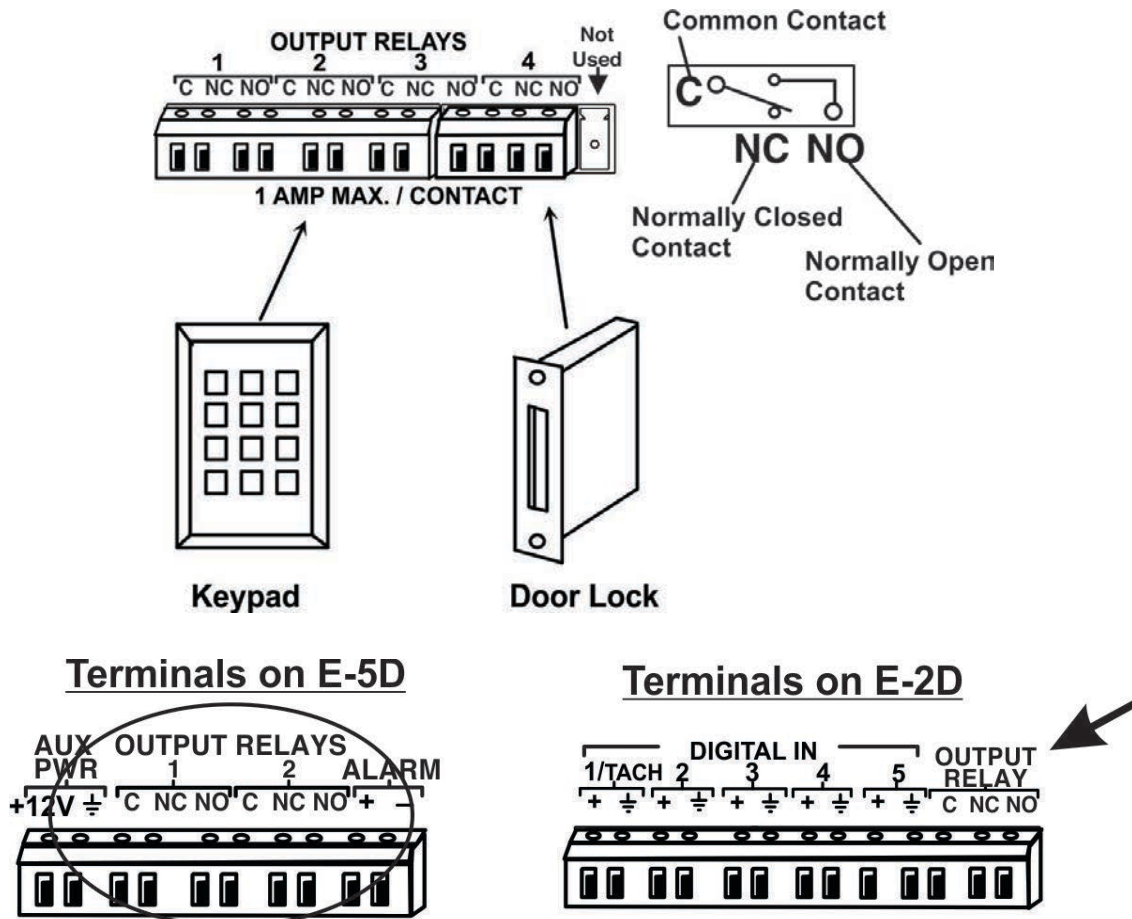

Figure 13- Install additional devices to output terminals

Terminal Connection for RS232

If control via serial connection is going to be used (i.e. using Telnet or SSH), serial control can be achieved using the “USB Console” port (all models) or the “RS232” port (E-16D only) or “RS232 AUX” port (E-5D only). A terminal connection is accessible by the user “root” only.

To use the “RS232” port, connect one end of a CAT5 patch cable (supplied) to the port labeled “RS232” on the rear of the ENVIROMUX. Plug the other end of the CAT5 cable into an RJ45-to-DB9F adapter (supplied), and connect the adapter to the RS232 port on the control terminal. Follow the instruction in the [Serial Control Manual](#) for configuration and use of the Serial Control feature.

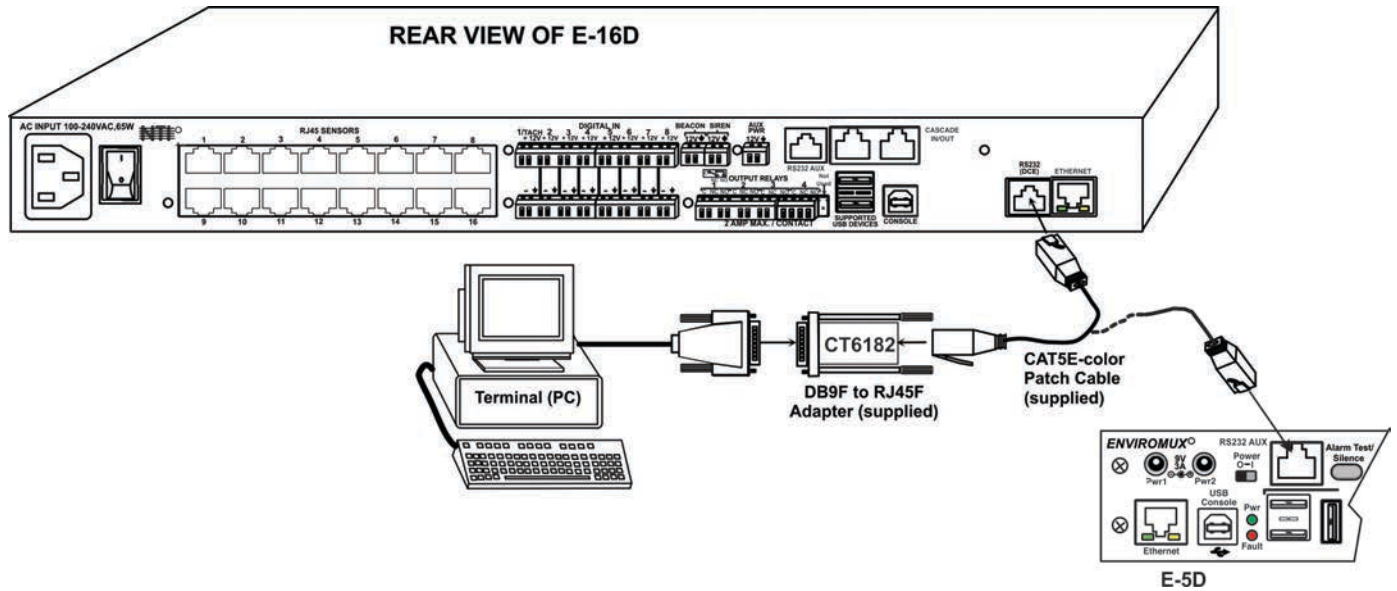

Figure 14- Connect a terminal for direct RS232 serial communication

To use the USB “CONSOLE” port, connect a USB cable (2 meter cable supplied) between the ENVIROMUX and your PC. Then install the drivers as described in the [Serial Control Manual](#).

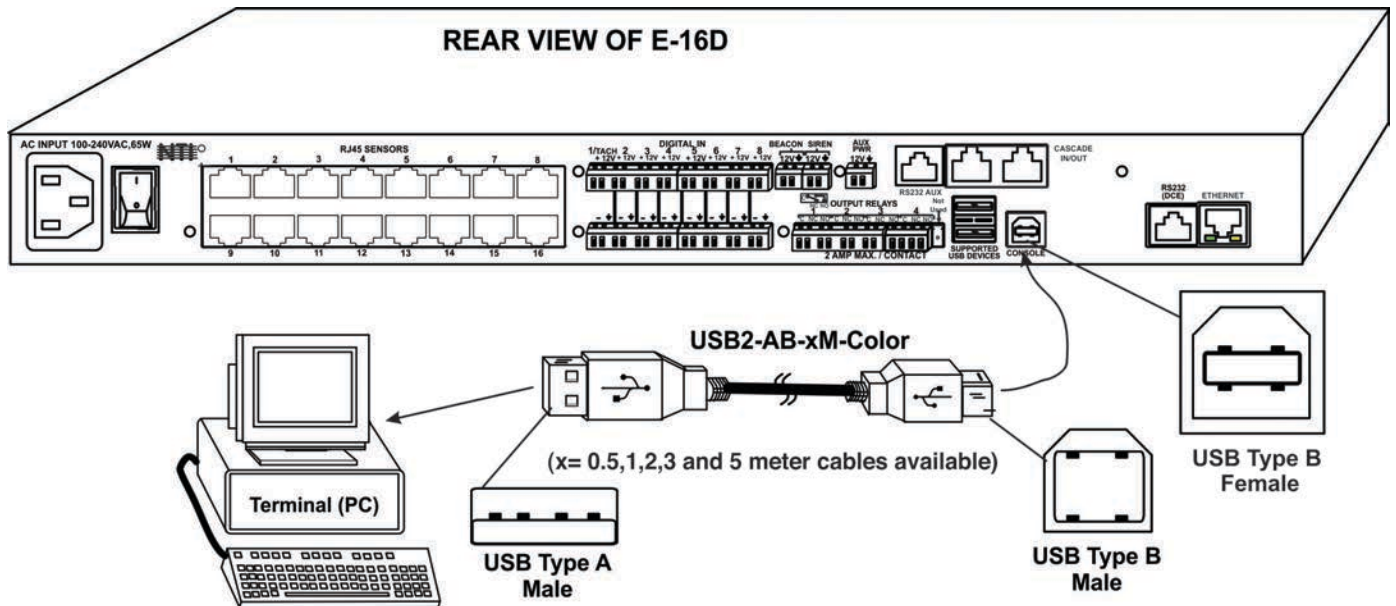

Figure 15- Connect a terminal using USB Console port

Ethernet Connection for Remote User Control

To make a remote connection, over the Ethernet, from anywhere on the local area network, connect a CAT5/5e/6 Ethernet cable with RJ45 male connectors on the ends, wired straight through (pin 1 to pin 1, pin 2 to pin 2, etc.). Up to 8 users can connect to the ENVIROMUX using the Ethernet at a time.

Note: A direct connection from a computer's Ethernet port to the ENVIROMUX "ETHERNET" port may also be made using the same cable.

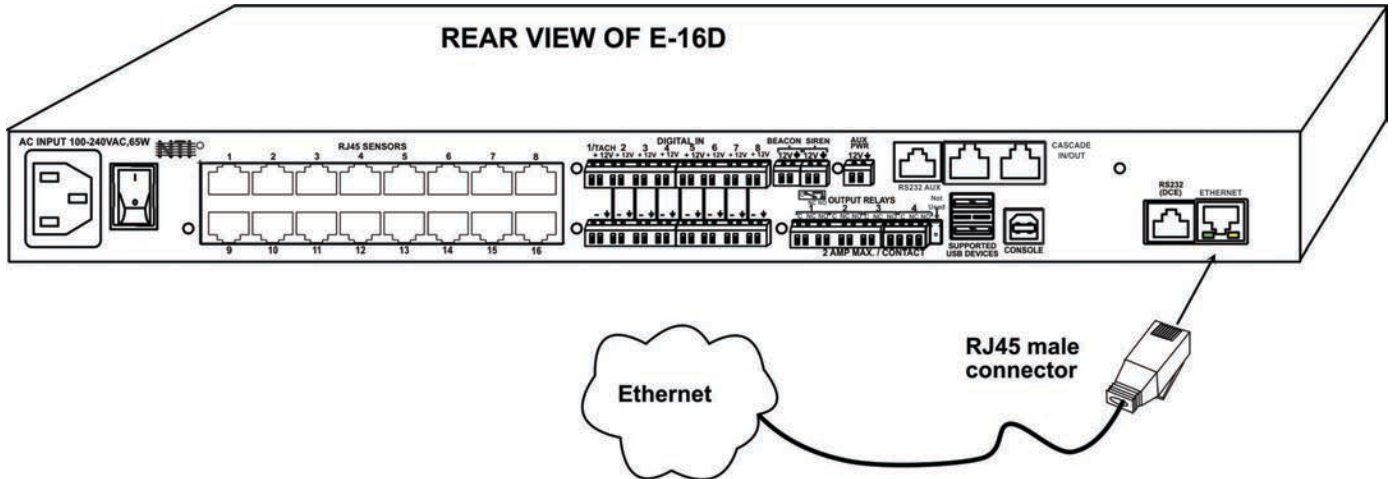

Figure 16- Connect ENVIROMUX to the Ethernet

For connection to the E-2D-POE, an Ethernet switch with PoE support can be used instead of (or in addition to) the included power supply. When the power supply is connected along with a PoE supported Ethernet connection, the power supply will act as backup if the Ethernet power is disconnected or lost.

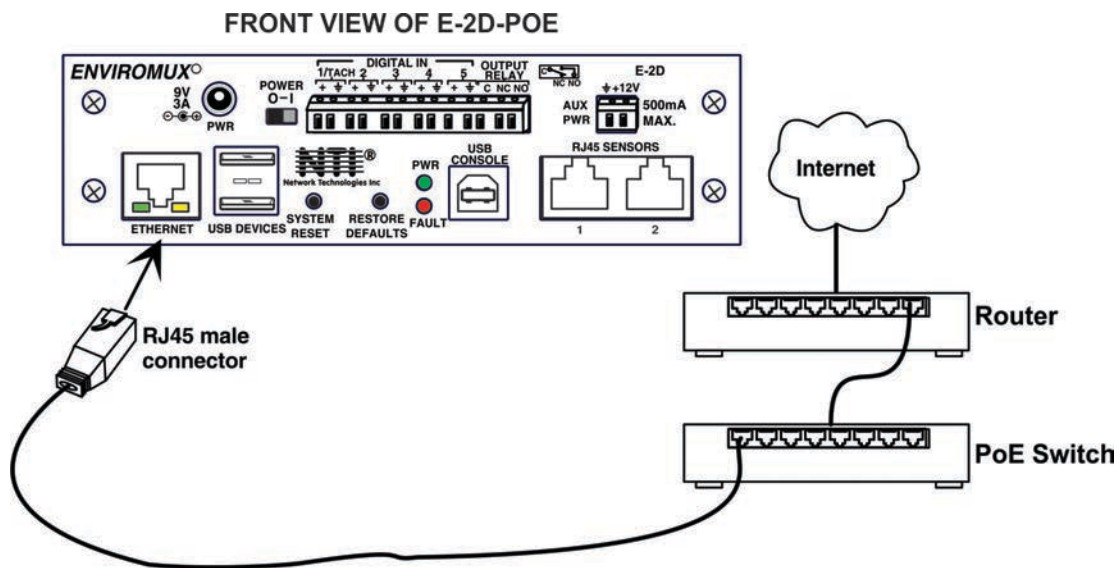

Figure 17- E-2D-POE with PoE Switch

Modem Connection

The ENVIROMUX includes support for a USB GSM modem to send alert notifications via SMS to a cell phone if desired. Using a modem each user can receive SMS alert messages directly on their cell phone. When a USB 3G/4G modem is used, SMS alert messages, all email messages, and web interface control over the ENVIROMUX is possible.

USB GSM Modem

To use a USB GSM Modem, a USB modem (with GSM SIM card configured for SMS messaging) can be connected to one of the USB ports on the ENVIROMUX. The remaining USB Type A connector(s) on the ENVIROMUX is available for the connection of a USB Flash Drive for data logging (pages 118 and 122).

Once installed, the ENVIROMUX will sense the modem and provide status information on the “Enterprise Setup” page in the web browser (page 77).

The USB GSM modems that have been tested and are confirmed to be compatible with the ENVIROMUX include:

- E-Lins M300D or M300W Industrial USB Modem (NTI# E-3GU-IND)
- Zoom 4595 Modem
- Huawei E3372h-510/153/607 (NTI# E-4GU-1/2/3)
- iCON GI1505(M) 3G Modem
- iCON GI0452 3G Modem
- Teltonica USB/G10 Modem

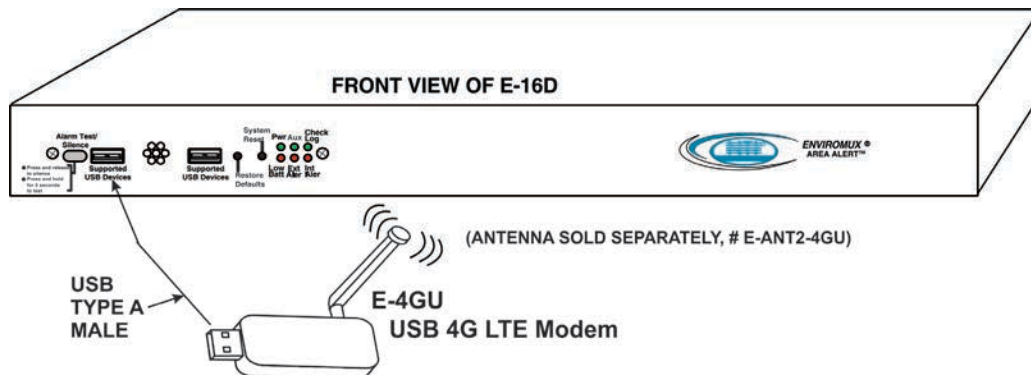

Figure 18- Install USB GSM Modem

Cell phone SIM card for GSM modem

A SIM card or *Subscriber Identity Module* is a portable memory chip used in some models of cellular telephones. It can be thought of as a mini hard disk that automatically activates the phone (or in this case the GSM modem) into which it is inserted.

SIM cards are available in four standard sizes. The first is the size of a credit card (85.60 mm x 53.98 mm x 0.76 mm). The next, more popular “mini” version has a width of 25 mm, a height of 15 mm, and a thickness of 0.76 mm. The third, “micro” version measures 15 mm x 12 mm x 0.76 mm, and lastly the “nano” version measures 12.3 mm x 8.8 mm x 0.67 mm.

Some cellular service providers use SIM cards. Verify with your service provider that their SIM card will work with GSM / 3G GSM modems before making a purchase.

Your USB modem can be used for 3 different levels of functionality:

- SMS Messaging Only
- 3G/4G Data Transfer And SMS Messaging
- 3G/4G Data Transfer, SMS Messaging, and Web Interface

SMS Messaging Only

When using your modem only for SMS messaging, make sure the SIM card is for GSM communication (not CDMA), configured to send SMS messages, and that it is not locked (some SIM cards are "locked" to search for a specific IMEI number of the phone to operate).

Note: *When configured for SMS messaging only, no access to the ENVIROMUX will be possible through the modem.*

For more details, see [How to Setup and Test SMS Messaging](#).

3G/4G Data Transfer And SMS Messaging

To use your USB modem for 3G/4G Data connection, your SIM card must be configured to support 3G/4G data connections and have either **public or private** IP address. Make sure the account associated with the SIM card also has SMS messaging enabled if this feature will be used. With 3G/4G data connection support, the ENVIROMUX can be configured (page 89) to send all alert messaging through the USB modem instead of requiring an Ethernet connection for these messages.

Note: *When configured for 3G/4G data transfer and SMS messaging only, no access to the ENVIROMUX will be possible through the modem.*

3G/4G Data Transfer, SMS Messaging, and Web Interface

To access the web interface through your USB modem, your SIM card must be configured to support 3G/4G data connections and have a **public** IP address. The ENVIROMUX can be configured (page 89) to send all alert messaging through the USB modem instead of requiring an Ethernet connection for these messages. With a public IP address, you will also be able to access the web interface using the IP address of the SIM card for full control of the ENVIROMUX through the modem.

Make sure the account associated with the SIM card also has SMS messaging enabled if this feature will be used.

Contact your service provider to obtain a SIM card with the features you desire.

SMS Relay Via SNMP

Your ENVIROMUX can be used as an SMS relay through an SNMP browser (requires firmware version 2.51 or later). SMS messages, up to 160 characters in length, can be sent to up to 4 different phone numbers each when your SNMP browser is properly configured. For more details, see [How to Setup SNMP](#).

SMS via User Configuration

Your ENVIROMUX can be configured to send a user SMS messages instead of email by configuring the carrier's text messaging address instead of a user's email address. See User contact settings on page 94 for more.

Power Connection-E-16D

Connect the power cord supplied to the IEC connector on the rear of E-16D. Plug the other end into AC mains and use the switch to power ON ENVIROMUX.

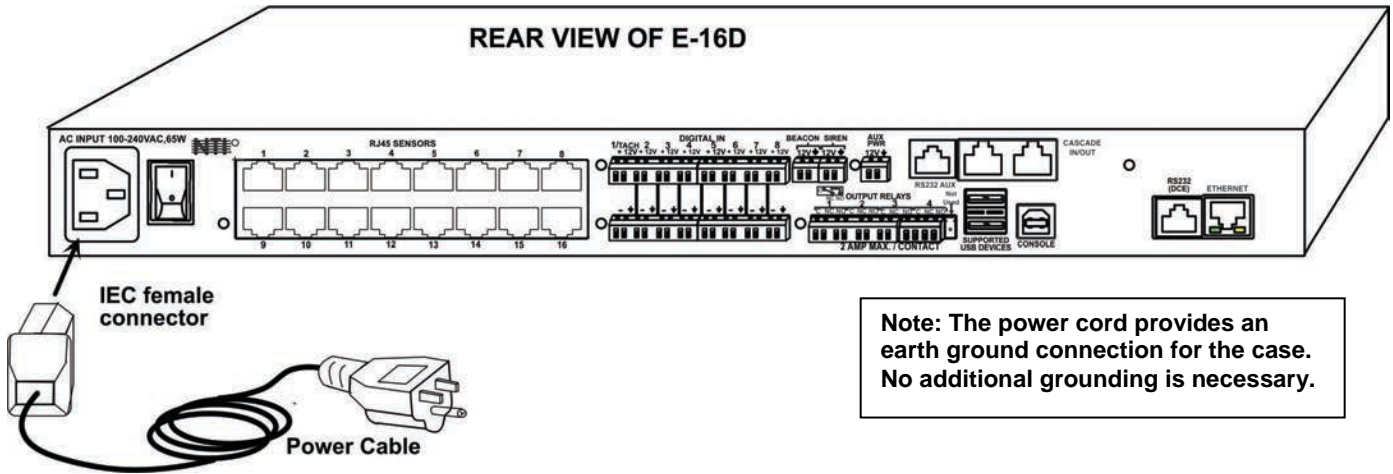

Figure 19- Connect the power cord

Dual Power Option

The E-16DDP has two IEC connectors on the rear, for connection to two separate power sources. If the power source connected to “PWR 1” fails, the ENVIROMUX will automatically and without interruption switch over to the power source connected to “PWR 2” before switching to the battery backup (page 121).

Note: If only one power source is used, it should be connected to “PWR 1”.

Note: The power ON/OFF switch is located on the front panel of ENVIROMUX when two IEC connectors are present.

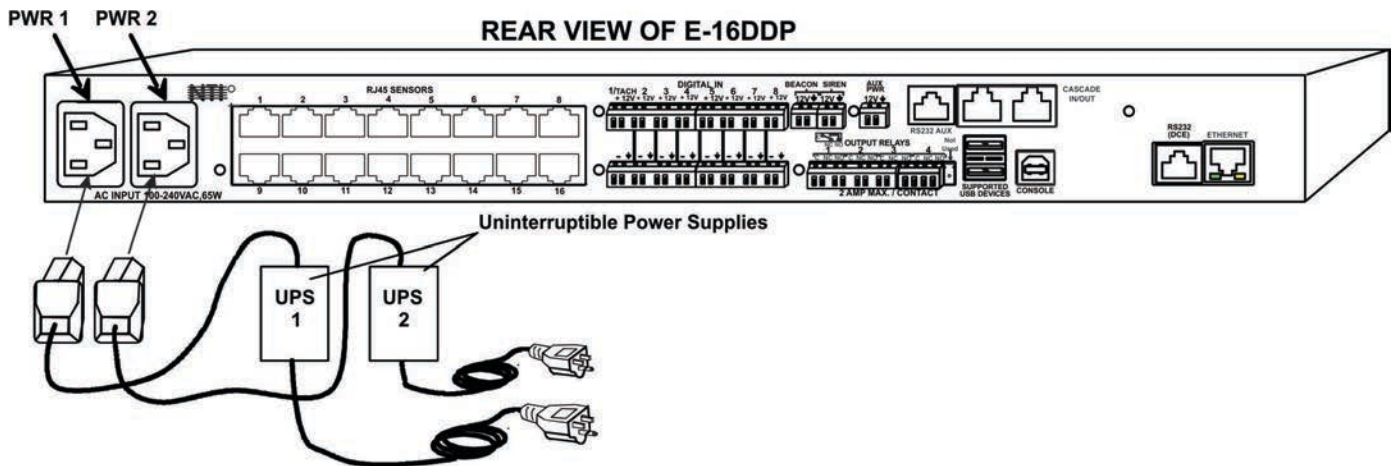

Figure 20- Power connections for ENVIROMUX with Dual Power Option

DC Power Option

The E-16D is available with connections for DC power connection. The E-16D-48V can be connected to a 36–72VDC (48VDC nominal) power supply. The E-16D-24V can be connected to a 18–36VDC (24VDC nominal) power supply. Each has connections on the rear for a user-supplied DC power supply (minimum 27 watt). This is typically used when the ENVIROMUX is installed in a Telecom environment. The E-16D-xxV will accept a DC power source with positive or negative polarity. A removable 3-pole screw terminal is provided for easy connection. The image below shows an E-16D-48VDP, which has dual 48VDC power connections for a dual power supply option (also available for the 24VDC model).

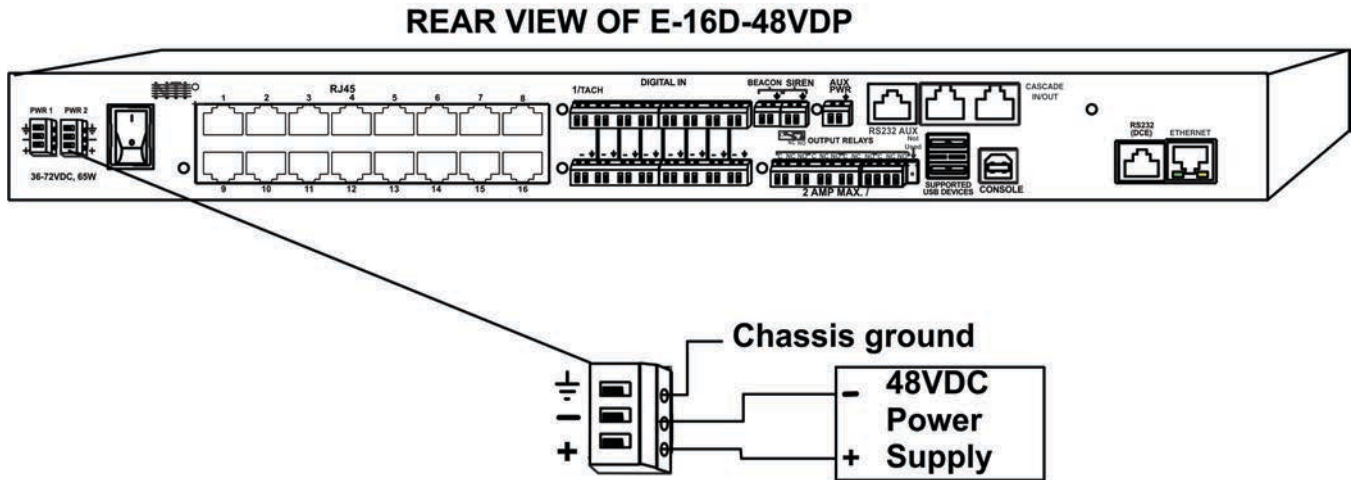

Figure 21- 48VDC Power Option Connections

Power Connection- E-5D/-2D

Note: Sensors should be connected before supplying power to the ENVIROMUX.

Connect the AC adapter to the connection marked "PWR1" or "PWR2" on the ENVIROMUX and plug it into an outlet. If you have an alternate source of 9V power for the ENVIROMUX, the second PWR connection is provided to make that source available. If the source connected to "PWR1" is lost for any reason, the ENVIROMUX will automatically switch to receiving power from the source connected to "PWR2".

The E-5D(B)-(-IND) and E-2D(B) (-IND) models will operate properly at an input voltage range of 9-12VDC

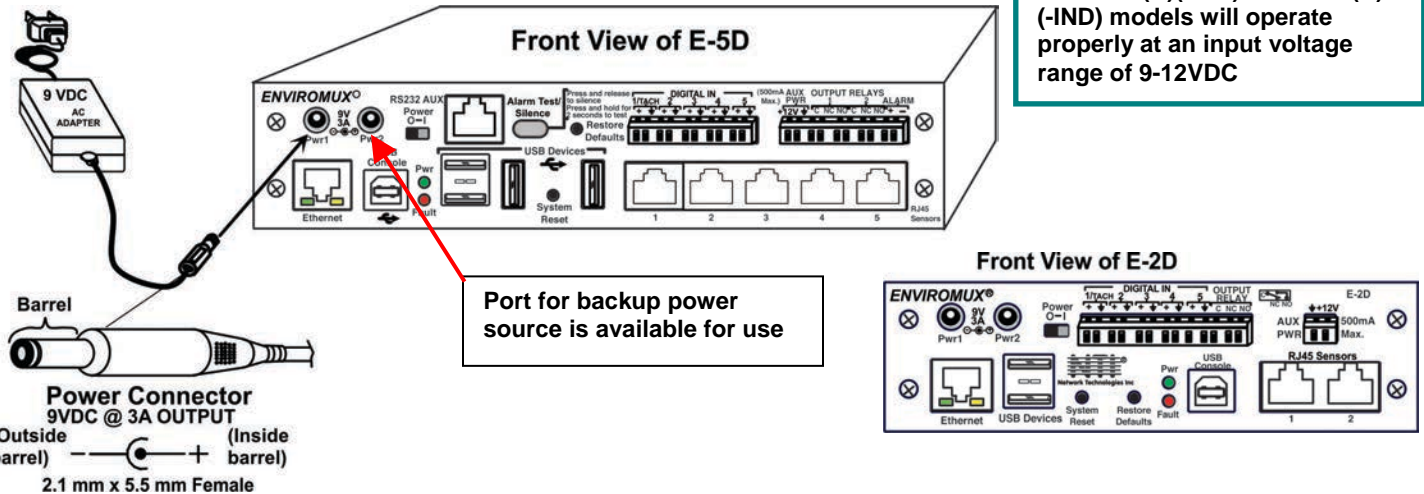

E-5D(B)-IND uses a 9VDC 5A power supply with 2.5mm x 5.5mm Female connector.

Figure 22- Connect the AC adapter and power-up

The E-2D-POE will be powered by an Ethernet connection to a switch with PoE support (see Figure 17) but can also be powered using the included AC adapter.

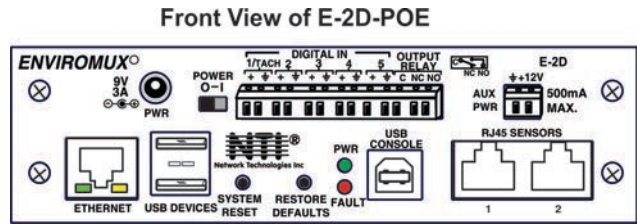

The E-5D-48V is available with connections for a 18~72VDC (24 or 48VDC nominal) user-supplied power supply. This is typically used when the ENVIROMUX is installed in a Telecom environment. The E-5D-48V will accept a DC power source with positive or negative polarity. A removable 3-pole screw terminal is provided for easy connection. The image below shows an E-5D-48VDP, which has dual 18-72VDC power connections for a dual power supply option.

For your convenience, the power jacks for connecting an AC adapter are also provided, and may be used as well. These jacks will accept 9-12VDC (9VDC 3A power supply may be purchased separately-order PWR-SPLY-9V3A). All power connections can be used simultaneously without damage to the ENVIROMUX.

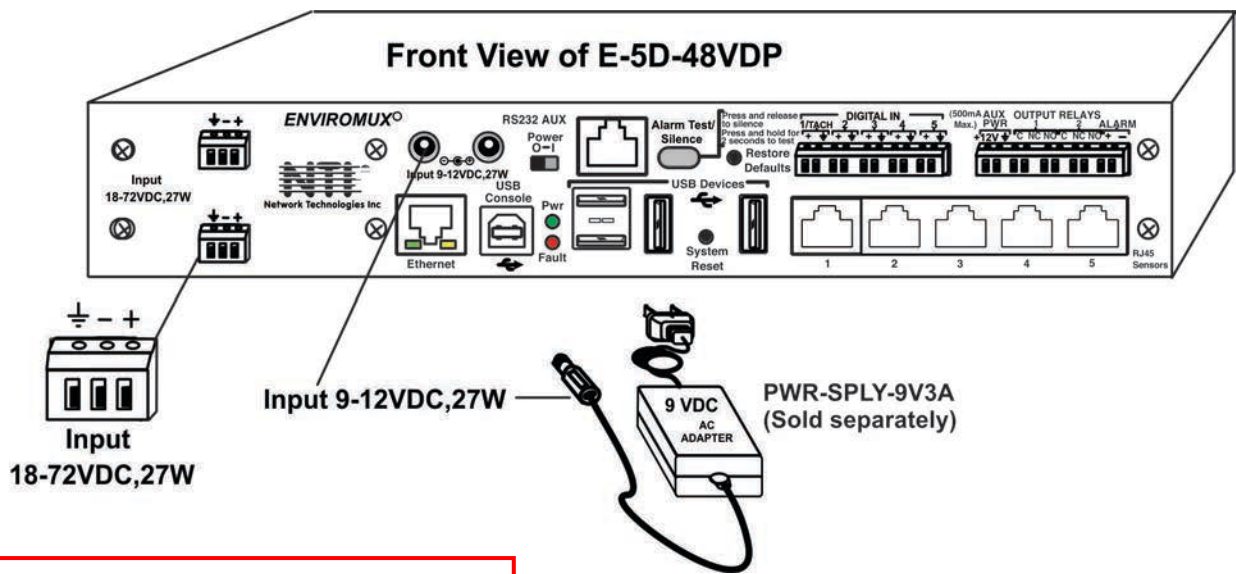

Note: The E-5D-48VINDLT has a narrower input voltage range of 36-72VDC.

Figure 23- Power connections on E-5D-48VDP

Note: The power supply monitor on the sensor summary page will only display the status of the 18-72VDC connections. The 9-12VDC power connections will be ignored on the E-5D-48V(DP) models.

Power Supply				
No.	Type	Value	Status	Action
1	Power Supply	OK	Normal	Ack Dismiss Edit
2	Power Supply	OK	Normal	Ack Dismiss Edit

Figure 24- Power Supply sensors-Summary Page

Remote RS232 Device Control

The “RS232 AUX” port can be used to connect a remote serially-controlled device (E-5D and -16D only). Once connected, a user named “rs232” can login to the ENVIROMUX from a command prompt and begin sending commands directly to the serial device.

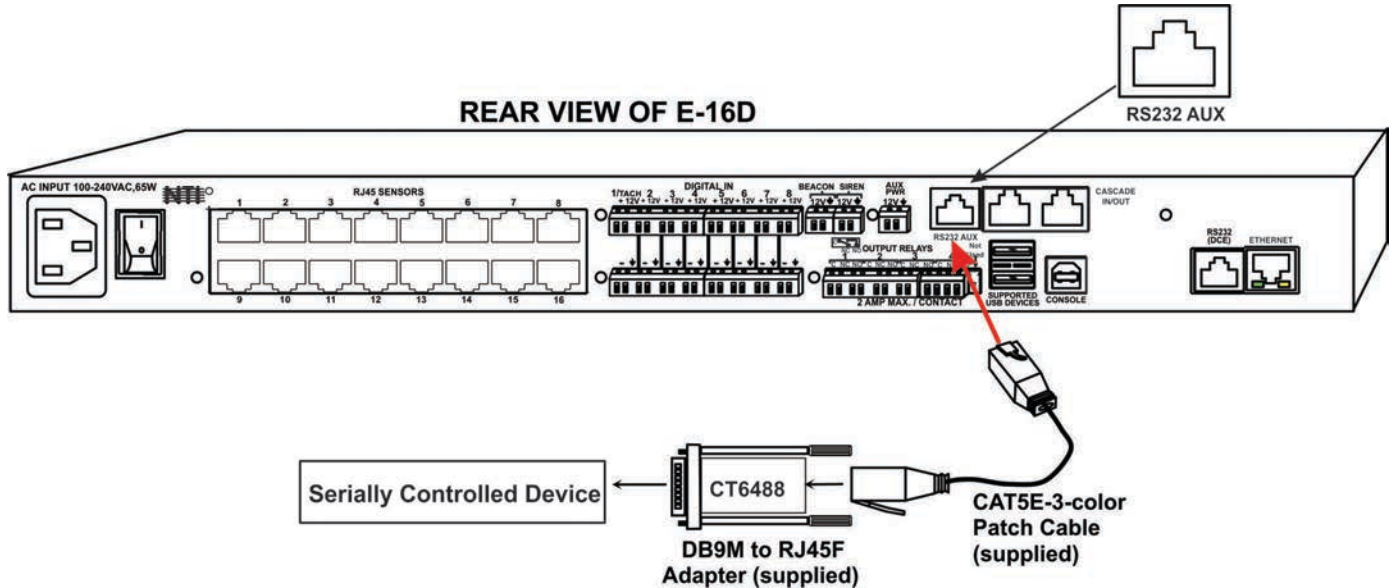

Figure 25- Connect serially controlled device

To control a remote serially-controlled device from the “RS232 AUX” port:

1. Configure the “Auxiliary Serial Port” under System Configuration (page 74) as a **Remote Serial Port** with the correct parameters for communication with the device.
2. Setup a user named “rs232” (**must be lowercase letters**) with password under User Configuration (page 92)

Configure User

[-] Account Settings	
Username	rs232 <small>The username for this user</small>
Admin	<input checked="" type="checkbox"/> <small>Grant this user administrative privileges</small>
Enabled	<input checked="" type="checkbox"/> <small>Users can only access the system if their account is enabled</small>
Password	•••••••• <small>The user's password to login to the system (for local authentication)</small>
Confirm	•••••••• <small>Confirm the entered password</small>
Title	Test RS232 Account <small>The user's title within the company</small>
Department	<input type="text"/> <small>The user's department within the company</small>
Company	<input type="text"/> <small>The name of the user's company</small>
[+] Group Settings	
[+] Contact Settings	
[+] Schedule Settings	
[+] SNMP Settings	
[Save]	

Figure 26- Create user "rs232"

3. Open a SSH client program (Putty, Tera Term, etc.), connect to the ENVIROMUX by entering the IP address of the ENVIROMUX.

Note: Make sure your SSH client is a recent version. Older SSH clients will not work with the ENVIROMUX.

4. When prompted for a login, enter “rs232”.

5. When prompted, enter the password you have assigned.

With a successful login you will receive the message “Connected to RS232 port”. You are now ready to send commands directly to the connected serially controlled device.

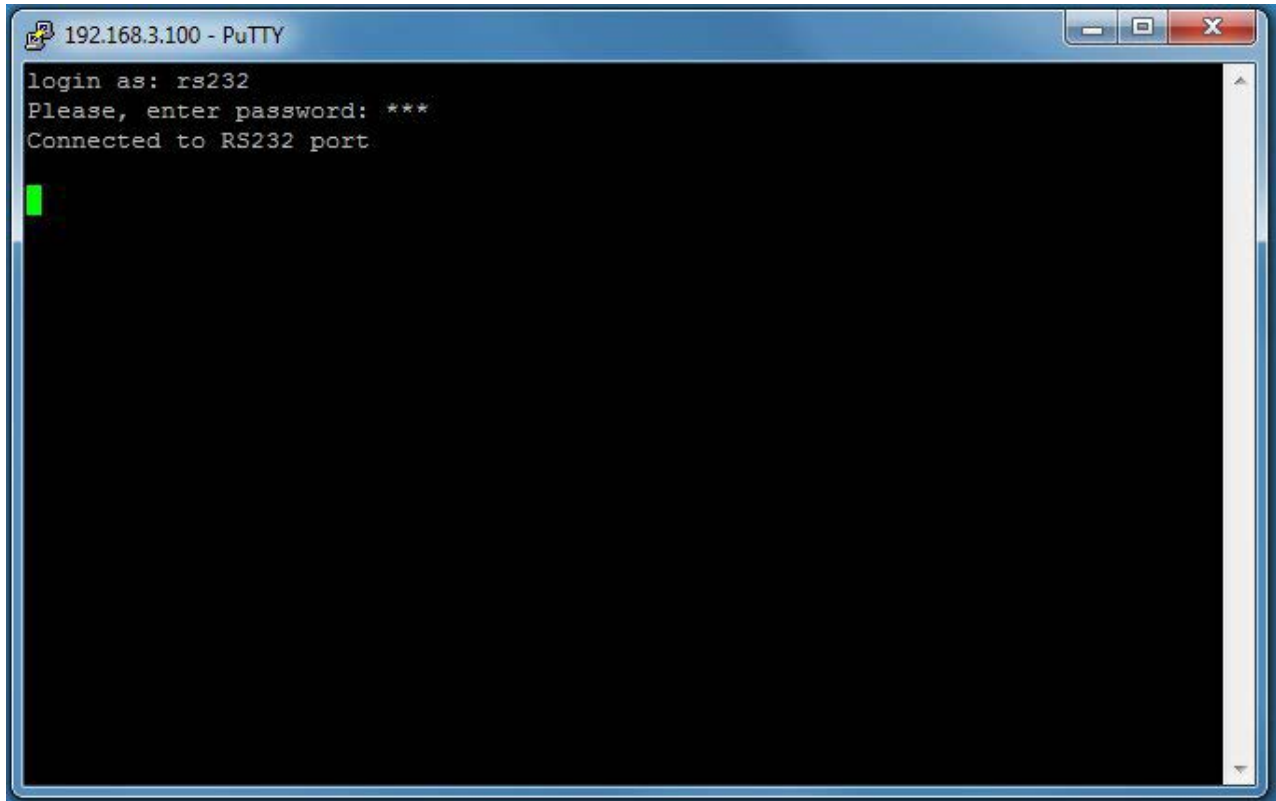

Figure 27- Connection to serial device successful

To exit the connection, close the command window.

OVERVIEW - USE AND OPERATION

The ENVIROMUX is controlled via RS232 or Ethernet using a terminal emulator, web browser, or SNMP monitor. The user interfaces are for viewing and configuring sensor data and system settings. However, full configuration of the system can be done only through the Web browser due to graphics limitations in the other interfaces.

The web interface allows for the configuration of the thresholds for all attached sensors, their alert methods, and the formats of the alerts. In addition, network information (IP address, subnet mask, default gateway, DNS, etc.), user administrative settings, and log settings can also be configured. All settings are saved in memory when applied. A user may also restore the unit back to its default settings at any time via the web interface (see page 73), text menu (see [Serial Control Manual](#)) or a button on the front panel (page 121).

Individual sensor status pages are available for each connected sensor. A sensor summary page allows the user to view the connected sensors' current values, threshold settings and alert statuses. Also, the user can view recorded sensor readings that have been stored in the system data log.

Sensors

The ENVIROMUX provides RJ45 sensor input jacks and screw terminal ports. Some available sensor configurations include Temperature, Humidity, or Temperature+Humidity, Liquid, Vibration, Smoke, Motion Sensor, Glassbreak detector, and AC Line Monitors. See page 2 for more on available sensors.

The temperature/humidity sensors have been given factory default settings and thresholds that can be changed (see page 39). Sensor readings can be reported continuously, only when readings change, or at a regular rate (for instance, a temperature reading could be updated once each hour).

Sensors connected to the terminals labeled "Digital In" must be manually configured, and can be any sensor of contact-closure / open-collector type that operate on 12VDC and 50mA, with a maximum load resistance of 10k Ω or less. (See page 54 for more info.)

IP Assignment

An IP address can be assigned to the ENVIROMUX through any of three methods:

- Using the NTI Device Discovery Tool (page 28)
- Through the web interface on the Network page (page 81)
- Using the RS232 interface ([Serial Control Manual](#))

Initially, IP configuration will be the easiest to change using the NTI Device Discovery Tool, which will search for NTI devices on the user's network and allow IP assignment to them through its web interface. Other settings for subnet mask and default gateway may also be configured (see page 28). These settings must be configured properly in order to access the ENVIROMUX web interface.

User Management

The ENVIROMUX supports up to 15 user accounts plus the root account (page 92). Each user account is protected by local password authentication. Each user may be assigned "User" or "Administrative" privileges. Users accessing the ENVIROMUX will be granted access to only the monitoring functions, and will be able to view the log. An account with "Administrative" privileges has all of the privileges necessary to view and configure network settings, add/edit/delete other user accounts, configure sensors, etc..

Alerts

A high and low threshold limit can be set for each temperature or humidity sensor within the operating range of the sensor. Each open collector/contact-closure sensor can be set as normally-open or normally-closed. When a sensor takes a reading that is outside a threshold or a contact-closure sensor is not in its normal condition, an alert notification can be generated. The user can specify how often alert notifications are provided. Also, there is an adjustable alert delay time involved with alert notifications. This means if a sensor's readings are moving in and out of the threshold boundaries within a configurable period of time, additional alert notifications will not be sent. Alerts may be sent if the condition of the sensor returns to normal or back within its threshold boundaries. Alert notifications (page 46) will be provided through any or all of six main methods:

- visible notification via the user interfaces (red LED on front panel, beacon, alert on webpage)
- emails (up to 16 different addresses)
- SNMP Traps
- SMS Messages (up to 68 different phone numbers)
- Syslog Messages
- audible notification via siren

Data and Event Logging

The ENVIROMUX can log sensor readings, sensor alerts, alert handling, sensor connections/removals, and user logins/logouts. The logs can be viewed at any time through the web interface (page 113). Additionally, as entries are generated, they can be emailed or sent as SNMP traps. Entries can be deleted from the logs via the web interface. The maximum size of the Data log is 1724 entries, and the maximum size of the Event Log is 1000 entries, each listed in chronological order. Each log's behavior upon reaching this maximum size can be configured, allowing the log to either wrap (overwrite oldest entries), stop logging, or clear and start over. The entire log can be downloaded as a plain text file from the web interface at any time. Log entries can be removed individually, in groups, or all at once.

Email

The ENVIROMUX can access an outgoing SMTP server (authenticated or non-authenticated, with or without TLS encryption) to send email. Outgoing mail may contain pre-formatted alert notifications or data log messages (samples on page 113). The user can configure what conditions cause emails to be sent. The ENVIROMUX's email address can be configured through the web interface on the Enterprise Setup page (page 77), and SMTP server information can be configured on the Network Setup page (page 81). Up to 16 outgoing email addresses (112 characters max. including commas) may be configured (corresponding to the 15 user and 1 root email addresses). An example of email configuration can be found in "[How to Setup Email](#)".

Syslog

The ENVIROMUX can send alerts as SYSLOG messages when a sensor enters/leaves alert mode, and for all log events. The destination for SYSLOG can be configured in each user profile (page 94). For detailed instructions on setting up Syslog, see "[How to setup Syslog](#)".

SNMP

The ENVIROMUX can send alerts as SNMP traps when a sensor enters/leaves alert mode, and for all log events. Using an SNMP MIB browser, a user can monitor all sensor statuses and system IP settings, as well as configure sensor thresholds, sensor names, and the system name. Click on the checkbox for SNMP under contacts (page 94) for each user that should receive SNMP messages. The SNMP agent supports SNMP v1, v2c and v3.

Note: *The SNMP MIB file (sems-16-v1.xx.mib), for use with an SNMP MIB browser, can be found at <http://www.networktechinc.com/download/d-environment-monitor-16.html>.*

Several SNMP related supplemental instructions can be found in "[How to setup SNMP](#)".

SNMP Sensors

The ENVIROMUX can now (firmware version 2.61 and later) poll up to 32 third-party SNMP devices (i.e. a UPS or Rebooter) and be setup to send alert messages for configured events based on the information received. Using [smart alert](#) events a user can be made aware when network connected devices perform outside of desired parameters. For SNMP v3 users, the Engine ID can be found on the System Information page (page 109).

Modbus TCP/IP Support

The ENVIROMUX is equipped with Modbus TCP/IP support to enable PLC controls to read the value/state of some of the sensors and read and command the state of relays. Specific instruction on this topic can be found [here](#).

External Modem

An external modem (GSM) can be connected to allow the system to send alert notifications via SMS messages. When a sensor crosses a threshold, an alert notification can be formatted to SMS message (see page 94) and the modem could transmit the message to pre-specified cellular numbers (up to 16- one for each user). The external modem can be supplied from an external power supply or from the USB port.

Power-on/Reset Operation

On power-up, after going through its boot sequence, the ENVIROMUX will launch the monitoring application, load any stored configuration values, and immediately identify and begin taking readings from any connected sensors. Alerts will be reported using the configured alert methods, and data will be logged using the stored preferences. A user can log in at any time after the system has launched the monitoring application (approximately 60 seconds after power is applied) to view and configure properties of the system and its sensors.

FYI: *The boot sequence can also be initiated manually using the System Reset button. See page 120 for details.*

Out-of-Box Operation

The operation of the unit directly out of the box is nearly identical to the Power-on/Reset operation. However, information about the unit will only be able to be monitored and controlled through the “RS232” or “CONSOLE” ports until valid network settings are assigned to the device (see page 81). The RS232 provides only limited configuration options, pertaining mostly to Ethernet settings.

Alert notifications will only be able to be viewed through the front panel until network settings are configured. Email and SNMP alert notifications must be configured within the web interface (page 72) before these methods can be used. The network settings must be compatible with the physical network to which the ENVIROMUX is attached. Once these configurations are made, they will be saved in the unit, even if the ENVIROMUX is powered-OFF.

Expandability

Multiple ENVIROMUX units may be used together on one system, so as to increase the number of sensors the user can have connected. Despite having multiple units, the user does not have to access the webpage of each ENVIROMUX individually. Up to 4 units can be cascaded from a single ENVIROMUX with all of the data from each of the units displayed on one webpage. For more details, see [How to Setup Cascaded Configuration](#).

DEVICE DISCOVERY TOOL

In order to easily locate NTI Devices on a network, the NTI Device Discovery Tool may be used. The Discover Tool can be downloaded from <http://www.networktechinc.com/download/d-environment-monitor-16.html>, unzipped and saved to a location on your PC. To open it just double-click on the file `NTIDiscover.jar`. This will open the NTI Device Discovery Tool.

Note: The Device Discovery Tool requires the Java Runtime Environment (version 6 or later) to operate. Here is a [link to the web page from which it can be downloaded](#).

Note: The computer using the Device Discovery Tool and the NTI Device must be connected to the same subnet in order for the Device Discovery Tool to work. If no devices are found, the message “No Devices Found” will be displayed.

Tip: If your Windows program asks which program to open the `NTIDiscover.jar` file with, select the Java program.

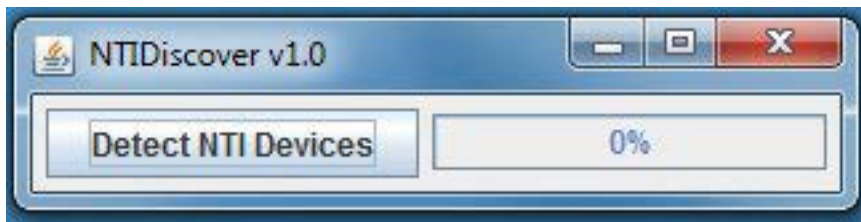

Figure 28- Device Discovery Tool

Click on the “**Detect NTI Devices**” button to start the discovery process. After a short time, the tool will display all NTI devices on your network, along with their network settings.

Device	MAC Address	IP Address	Mask	Gateway			
ENVIROMUX-SEMS-16	00:0C:82:03:03:E8	192.168.3.80	255.255.255.0	192.168.3.3	Submit	Blink LED	
ENVIROMUX-5D	00:0C:82:10:00:05	192.168.3.25	255.255.255.0	192.168.3.3	Submit	Blink LED	
IPDU-Sx	00:0C:82:08:00:B2	192.168.3.85	255.255.255.0	192.168.3.3	Submit	Blink LED	
ENVIROMUX-2DB	00:0C:82:0E:00:08	192.168.3.83	255.255.255.0	192.168.3.3	Submit	Blink LED	
VEEMUX-MXN-C5AV	00:0C:82:09:00:25	192.168.3.82	255.255.255.0	192.168.3.3	Submit	Blink LED	
VEEMUX-DVI	00:0C:82:07:01:8B	192.168.3.86	255.255.255.0	192.168.3.3	Submit	Blink LED	
Submit All					Refresh		Close

How to Use the Device Discovery Tool

To Change a Device’s Settings, within the row of the device whose settings you wish to change, type in a new setting and click on the **Enter** key, or the **Submit** button on that row. If the tool discovers more than one device, the settings for all devices can be changed and you can click on the **Submit All** button to submit all changes at once.

To Refresh the list of devices, click on the **Refresh** button.

To Blink the LEDs of the unit, click on the **Blink LED** button (This feature is not supported on all products.) The **Blink LED** button will change to a “**Blinking...**” button. The LEDs of the unit will blink until the **Blinking...** button is clicked on, or the NTI Device Discovery Application is closed. The LEDs will automatically cease blinking after 2 hours.

To Stop the LEDs of the unit from blinking, click on the **Blinking...** button. The **Blinking...** button will change to a **Blink LED** button.

USE AND OPERATION VIA WEB INTERFACE

A user may monitor and configure the settings of any device connected to the ENVIROMUX using the Web Interface via any web browser (see page 5 for supported web browsers). To enable the Web Interface, connect the ENVIROMUX to the Ethernet (page 17). Use the Device Discovery Tool (page 28) to setup the network settings. Then, to access the web interface controls, the user must log in.

Note: In order to view all of the graphics in the Web Interface, the browser's JavaScript and Java must be enabled.

By default, the ENVIROMUX is configured to dynamically assign network settings received from a DHCP server on the network it is connected to. (This can be changed to a static IP address to manually enter these settings in the Network Settings on page 81.) The ENVIROMUX will search for a DHCP server to automatically assign its IP address each time the unit is powered up. If the ENVIROMUX does not find a DHCP server, the address entered into the static IP address field (page 81 -default address shown below) will be used. If a DHCP server on the network has assigned the IP address, use the Device Discovery Tool to identify the IP address to enter when logging in to the ENVIROMUX.

Note: The computer using the Device Discovery Tool and the NTI Device must be connected to the same subnet in order for the Device Discovery Tool to work. If no devices are found, the message "No Devices Found" will be displayed.

Log In and Enter Password

To access the web interface, type the current IP address into the address bar of the web browser. (The default IP address for the ENVIROMUX is shown below):

http://192.168.1.21

Note: If an E-4GU USB modem is installed (page 18) and configured to enable access to the web interface through it (page 89), you can instead enter the IP address of the SIM card account (requires E-xD firmware version 2.5 or later.) If the ENVIROMUX is properly configured, you can view the SIM card IP address on the system information page (page 109).

Note: If HTTPS pages cannot be viewed in the browser ("The page cannot be displayed" message appears) try to disable SSL 2.0 and TLS 1.0 from advanced options of the browser.

A log in prompt requiring a username and password will appear:

Username = root

Password = nti

(lower case letters only)

Note: usernames and passwords are case sensitive

Figure 29- Login prompt to access web interface

With a successful log in, a screen similar to the following will appear:

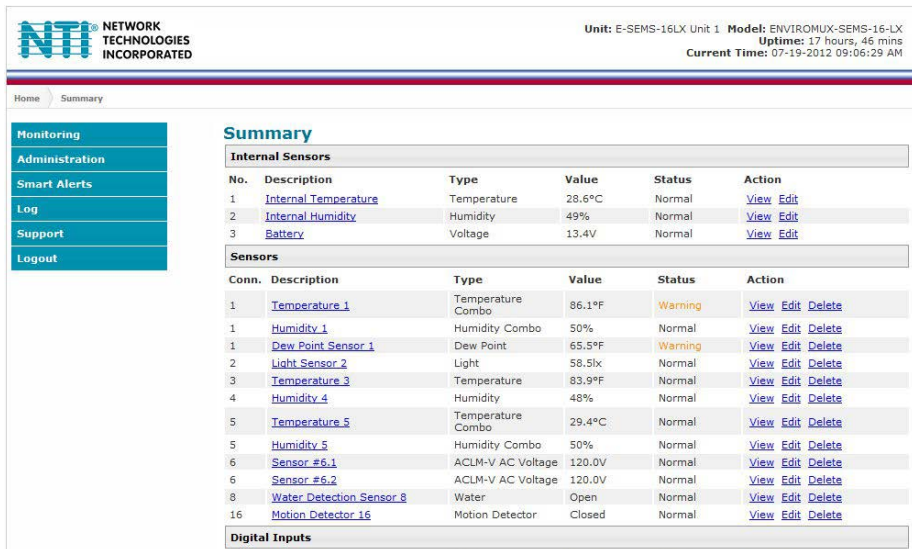

Figure 30- Summary page

The initial page includes the Summary page, and a menu to the left with access to all pages used to manage the functions of the ENVIROMUX.

Function	Description
MONITORING	Monitor all the sensor and data input received by the ENVIROMUX (below)
ADMINISTRATION	Configure all network and multi-user access settings (page 72)
SMART ALERTS	View and configure the Events used for Smart Alerts and the Smart Alerts themselves (see supplement for more on Smart Alerts)
LOG	View and configure the Event and Data Logs (page 116)
SUPPORT	Links for downloading a manual, the MIB file, or firmware upgrades
LOGOUT	Log the user out of the ENVIROMUX web interface

Alternative initial page

If you want the ENVIROMUX to open to a specific web interface page (other than the Summary page above), simply enter the URL of the desired page in the address bar of the web browser. After entering a valid user name and password, you will be taken directly to that page. In the example below, the `<ip address>/users.asp` was entered.

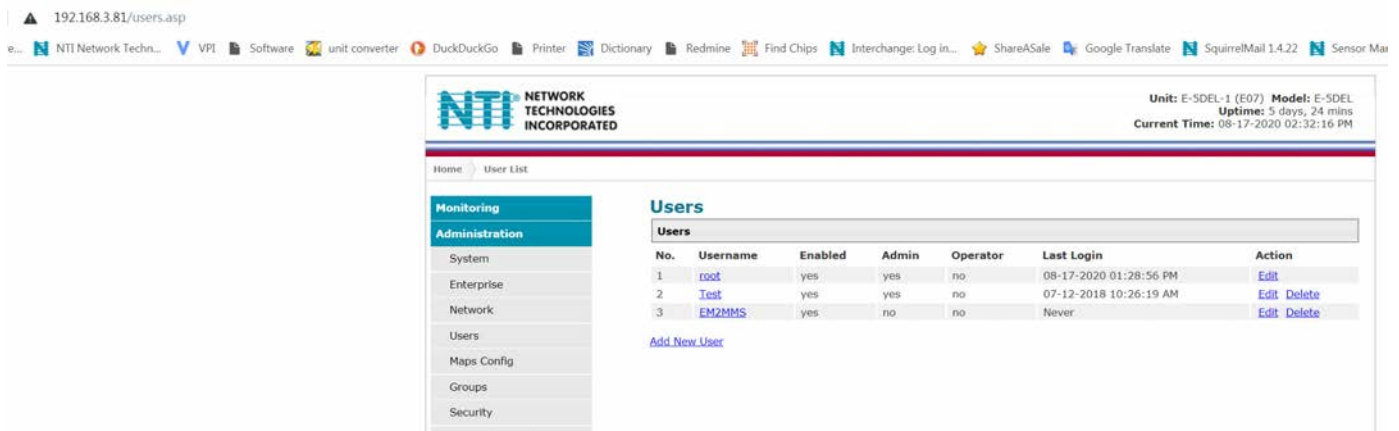

Figure 31- Alternative initial page in Web Interface

Monitoring

Under Monitoring, there are links to view the sensors, IP cameras, IP address data and more being monitored by ENVIROMUX.

Topic	Description
Summary	Lists all monitored items , including their type, description, value, and status
Maps	Display maps that have been configured to show locations of sensors (page 99)
Alarm Information	Lists all sensors that are in alarm state including their type, description, value, and status (page 36)
Sensors	Provides a link to view the status of specific Internal and External Sensors (page 36 and 43)
Digital Inputs	Provides a link to view the status of each Digital Input (page 54)
IP Devices	Provides a link to view the status of only the IP Devices and a link to add them (page 59)
IP Sensors	Provides a link to view the status of each IP Sensor configured (page 63)
SNMP Sensors	Provides a link to view the status of SNMP monitored conditions in network-connected devices
Output Relays	Provides a link to view the status of each Output Relay (page 57)
IP Cameras	Provides a link to view each IP camera defined- with a link to the configuration page (page 59)
Power Supplies	Provides a link to view the status of each power supply- with a link to the configuration page (page 33)

Summary Page

The Summary Page displays the data for all categories of monitored items:

Category	Description
Internal Sensors	there are three inside the ENVIROMUX
Sensors	sensors that connect to the RJ45 connectors
Digital Inputs	sensors that connect to the terminals "Digital In"
IP Devices	IP Addresses that can be monitored by ENVIROMUX
IP Sensors	sensors connected to E-MICRO that are being monitored
SNMP Sensors	Monitored SNMP-based sensor conditions
Output Relays	Relays that open or close depending on alert status
Remote Digital Inputs	Sensors connected to E-DI16DO(R)16 Digital Input/Output Expanders (page 54)
Remote Output Relays	Status of output relays on E-DI16DO(R)16 Digital Input/Output Expanders
Power Supply	Indicates the status of the power supply(s)
Smart Alerts	Displays the status of each Smart Alert configuration and provides link to respond when triggered (see supplement for more on Smart Alerts)

To see the settings of each sensor, click on the link in the description column for the desired sensor. Click on the browser's Back button to return to the summary.

Internal sensors measure the inside of the E-16D/E-5D, not the environment the ENVIROMUX is mounted in. As a result, it typically will read 3-8°C warmer than the ambient temperature.

Multi-function sensor (see page 38)

Sensors

Internal Sensors					
No.	Description	Type	Value	Status	Action
1	Internal Temperature	Temperature	27.3°C	Normal	View Edit
2	Internal Humidity	Humidity	41%	Normal	View Edit
3	Battery	Voltage	13.4V	Normal	View Edit

Sensors					
Conn.	Description	Type	Value	Status	Action
1	Temperature 1	Temperature Combo	84.0°F	Normal	View Edit Delete
1	Humidity 1	Humidity Combo	37%	Normal	View Edit Delete
1	Dew Point Sensor 1	Dew Point	54.7°F	Normal	View Edit Delete
2	Light Sensor 2	Light	51.7lx	Normal	View Edit Delete
3	Temperature 3	Temperature	81.8°F	Normal	View Edit Delete
4	Humidity 4	Humidity	36%	Normal	View Edit Delete
5	Temperature 5	Temperature Combo	28.2°C	Normal	View Edit Delete
5	Humidity 5	Humidity Combo	38%	Normal	View Edit Delete
6	Sensor #6.1	ACLM-V AC Voltage	120.0V	Normal	View Edit Delete
6	Sensor #6.2	ACLM-V AC Voltage	120.0V	Normal	View Edit Delete
8	Water Detection Sensor 8	Water	Open	Normal	View Edit Delete
16	Motion Detector 16	Motion Detector	Closed	Normal	View Edit Delete

[Add New Sensor](#)

To delete a sensor from this list, select "Delete". A pop-up confirmation window will appear before removal takes place.

Figure 32- Summary Page

Note: The E-16D / E-5D internal sensor is not intended to measure room temperature/humidity. This sensor measures the environment inside the metal case which is affected by the heat generated by the power supplies as well as the amount of airflow moving through the unit. Typically this sensor will read 3-8°C (37-46°F) above room temperature.

Power Supplies

The status of the power supply can be seen, and when a dual power supply model is present, both power supplies will be shown. Click on the power supply to open a web page that displays the type of item sensed, the status of the power supply, and the time and date of the most recent alert sent regarding the power supply.

AC Power				
No.	Type	Value	Status	Action
1	AC Power	OK	Normal	Ack Dismiss Edit
2	AC Power	OK	Normal	Ack Dismiss Edit

Figure 33- Power Supply status- Dual Power model

If the power supply is in alert status, the user has the option to either **acknowledge** the alert or **dismiss** it. If the user acknowledges the alert, no additional alert messages will be sent during that alert status cycle. If the user dismisses the alert, another alert message will be sent once the “notify again after” time designated on the configuration page (below) elapses.

The **Edit** option allows the user to apply a description for and configure alert parameters of the power supply.

Power Supply Alert Configuration

Power Supply Alerts Configuration

Power Supply Settings

Description
Descriptive name for the power supply

Power Supply 2 Alert Settings

Logs Sensor sends notifications for Group 1

Sensors & Power Supplies Sensor sends notifications for Group 2

Digital Inputs Sensor sends notifications for Group 3

IP Devices Sensor sends notifications for Group 4

IP Sensors Sensor sends notifications for Group 5

Output Relays Sensor sends notifications for Group 6

Events Sensor sends notifications for Group 7

Smart Alerts Sensor sends notifications for Group 8

Disable Alerts Disable alert notifications for Power Supply

Notify Again Time Min
Time after which alert notifications will be sent again

Figure 34- Power Supply alerts configuration-part 1

Notify on return to normal	<input checked="" type="checkbox"/>	Send a notification when this Power Supply returns to normal status
Auto acknowledge	<input checked="" type="checkbox"/>	Automatically acknowledge alert when Power Supply returns to normal status
Enable Syslog Alerts	<input checked="" type="checkbox"/>	Send alerts for this Power Supply via syslog
Enable SNMP Traps	<input checked="" type="checkbox"/>	Send alerts for this Power Supply via SNMP traps
Enable E-mail Alerts	<input checked="" type="checkbox"/>	Send alerts for this Power Supply via e-mail
E-mail Subject	<input type="text" value="E2DB E08 Power Supply 2 Alert"/>	
	Subject of e-mails sent for alerts	
Send custom SMS	<input type="checkbox"/>	Replace standard SMS with a customized message
Customized SMS	<input type="text"/>	
	Customized SMS message sent for alerts	
Enable SMS Alerts	<input type="checkbox"/>	Send alerts for this Power Supply via SMS
Enable Siren/Beacon alarm	<input type="checkbox"/>	Turn on the siren/beacon alarm when Power Supply goes to alert
Associated Output Relay	<input type="text" value="None"/>	Name of the output relay that can be controlled by this Power Supply
Output Relay status on alert	<input type="text" value="Inactive"/>	Status of the output relay when going to alert
Output Relay status on return from alert	<input type="text" value="Inactive"/>	Status of the output relay when returning from alert
<input type="button" value="Save"/>		

Figure 35- Power Supply alerts configuration-part 2

Alert Settings

Group: This is the group (or groups) of sensors the power supply sensor will belong to. Users that subscribe to alerts from this group will receive alerts from the power supply sensor. Each sensor can be configured to send alerts. Up to 8 sensor groups can be defined. Each user can receive alerts from any or all of the sensor groups.

Disable Alerts: *Place a checkmark here if you don't want the ENVIROMUX to send alert messages regarding the AC power sensor.*

Note: *If alerts for a power supply are disabled, the associated output action will still take place. There just won't be any alert notifications that this is occurring. For example, this might be used to turn ON a device, such as a beacon, when the power supply loses power, and OFF again when power is restored. An alert message may not be desired under these circumstances.*

Note: *if the user wants to disable alerts for a power supply after the power supply is already in alert status, the user must either acknowledge or dismiss the alert first.*

Note: *In the event of a line power failure, the battery backup (page 121) will power the ENVIROMUX for up to 1 hour.*

Notify Again: Specifies the amount of time before an alert message is repeated. The repeated alert can be set to occur from 1-999 seconds, minutes, or hours.

Notify on return to normal: The user can also be notified when the power supply has returned to the normal operation by selecting the "Notify on return to normal" box.

Alert Notifications

The alert can be configured to notify one or more users via email, SNMP traps (v1,v2c, v3), Syslog messages, or SMS alerts. It can also activate an audible siren, or an alarm beacon. Alerts are also indicated on the "Int Alert" or "Ext Alert " LEDs on the front of the ENVIROMUX and in the WEB interface.

When SMS alerts is enabled, the user has to option to enable the customization of the SMS message. Select "Send custom SMS" and enter up to 160 characters) to be sent with an SMS Alert.

Outputs

Each power supply can be associated with one of the connections labeled "Output Relays" (see page 15 or 57), and that connection can be set to "active" or "inactive" pertaining to the state of the contacts of the relay either on alert, or when returning to normal. The tamper can also block the output command generated by the alert. In this way other devices can be controlled by power supply alerts.

Alarm Summary

To view only those sensors in an alarm state, select the Alarm Summary page under Monitoring. To enable or disable all alerts, use the "Alert Manage" buttons at the bottom of this page.

Alarm Summary

Internal Sensors					
No.	Description	Type	Value	Status	Action
1	E-16D-M Internal Temperature	Temperature	78.1°F	Alarm	View Edit
S1-1	E-16D-S1 Internal Temperature	Temperature	78.5°F	Alarm	View Edit

Sensors					
Conn.	Description	Type	Value	Status	Action
6	E-16D-M ACLMV-6-V1	ACLM-V AC Voltage	96.6V	Alarm	View Edit Delete
6	E-16D-M AVLMV-6-F1	Frequency	56.7Hz	Warning	View Edit Delete
6	E-16D-M AVLMV-6-V2	ACLM-V AC Voltage	96.7V	Alarm	View Edit Delete
6	E-16D-M ACLMV-6-F2	Frequency	56.7Hz	Warning	View Edit Delete

Digital Inputs					
Conn.	Description	Type	Value	Status	Action
3	E-16D-M Test Switch DI3	Digital Input	Closed	Alarm	View Edit Delete
S1-5	16D-S1 Test Switch DI-5	Digital Input	Closed	Alarm	View Edit Delete

IP Devices					
No.	Description	Type	Value	Status	Action
13	Google	IP Device	Not Responding	Alarm	View Edit Delete

IP Sensors					
No.	Description	Type	Value	Status	Action
1	TRHP P02			Responding	Edit Delete
E.4	Temperature #2	Temperature	28.5°C	Alarm	View Edit

Remote Digital Inputs					
Conn.	Description	Type	Value	Status	Action
S1-2.1	S1-2 Test Input 1	Remote Digital Input	Closed	Alarm	View Edit Delete

Power Supply					
No.	Type	Value	Status	Action	
1	Power Supply	Down	Alarm	Ack	Dismiss Edit
S1-1	Power Supply	Down	Alarm	Ack	Dismiss Edit

Events						
No.	Event Description	Sensor	Trigger Val.	Current Val.	Status	Action
10	Event #10 E-16D-M Test Switch DI3	E-16D-M Test Switch DI3	Closed	Closed	Triggered	Ack Dismiss Delete

Smart Alerts					
No.	Smart Alert Description	Status	Action		
1	E-16D-M Test Switch DI3	Responding	Ack	Dismiss	Edit

Alert Manage	
<input type="button" value="Enable Global Alerts"/>	<input type="button" value="Disable Global Alerts"/>

Red = Critical alert alarm

Orange = Non-critical alert alarm

Black = Sensor is in normal status

Figure 36- Alarm Summary Page

Internal Sensors

E-16D and -5D have three on-board sensors, which are permanently present:

- one temperature sensor
- one humidity sensor
- one power (battery) sensor

Internal sensors are monitored and fully configurable just as External Sensors are (see Figure 39 and page 43) except that they do not have a box for "Enable Disconnection Alert" since they cannot be disconnected.

The internal and external temperature sensor and humidity sensor also include an **Offset** feature. The internal sensors measure the internal environment of the ENVIROMUX, however that value may be different than the environment the ENVIROMUX is actually mounted in. If you know what the difference is, you can use the "Offset" block to enter a value, positive or negative, and that will be applied to the measured value. The resulting difference will be the temperature or humidity that is reported on the Summary page.

For example, if the measured temperature is 75°F, and the environment is typically 5 degrees cooler, enter a value of "-5", click "Save", and the reported value will now be 70°F.

Offset	<input type="text" value="1.0"/>
---------------	----------------------------------

Internal sensors are always shown in the left menu of the web page and they cannot be removed.

S1 Internal Temperature Configuration (Type: Temperature)

Sensor Settings

Description	<input type="text" value="S1 Internal Temperature"/> <small>Descriptive name for the sensor</small>
Name in LED Display	<input type="checkbox"/> <input type="text"/> <small>Optional short name of the sensor as viewed in the LED Display(14 characters limit)</small>
Units	<input type="text" value="Deg. F"/> <input type="button" value="v"/> <small>Select the units for the sensor</small>
Min. Level	<input type="text" value="-40.0"/> <small>Min. supported value for the sensor</small>
Max. Level	<input type="text" value="185.0"/> <small>Max. supported value for the sensor</small>
Min. Non-Critical Threshold	<input type="text" value="60.0"/> <small>Min. threshold below which indicates a non-critical alert condition</small>
Max. Non-Critical Threshold	<input type="text" value="100.0"/> <small>Max. threshold above which indicates a non-critical alert condition</small>
Min. Critical Threshold	<input type="text" value="55.0"/> <small>Min. threshold below which indicates an alert condition</small>
Max. Critical Threshold	<input type="text" value="110.0"/> <small>Max. threshold above which indicates an alert condition</small>
Refresh Rate	<input type="text" value="1"/> <input type="button" value="Sec"/> <input type="button" value="v"/> <small>The refresh rate at which the sensor view is updated</small>
Enable Graph	<input type="checkbox"/> <small>Enable graph for this sensor</small>
Offset	<input type="text" value="0.0"/> ←

Group Settings

Non-Critical Alert Settings

Critical Alert Settings

Data Logging

Alert Simulation

Figure 37- Internal Sensor Configuration

ASHRAE Recommendation

According to ASHRAE's committee 9.9 for mission critical facilities, a class A1 data center can range in temperature from 59°F to 89.6°F and in relative humidity from 20% to 80%. This is very important for energy efficiency.

Temperatures for small hub rooms: 18-27°C / 64-80°F with ambient room humidity: 40% - 60% RH.

External Sensors

The External Sensors are those that connect through RJ45 connectors. There are two types of external sensors supported by the RJ45 connectors: **RS485 Sensors** and **Contact Sensors**. Up to 750 External Sensor values can be monitored. Each sensor connected may provide from 1 to 33 values.

RS485 Sensors

The following are some of the RS485 sensors supported:

- Temperature Sensor (E-STs/STs-O/STSP)
- Combined Temperature + Humidity + Dewpoint sensor (E-STHSM/STHSB)
- Current Sensor Adapter (E-S420MA-24V)
- Voltage Detector Converter (E-S60VDC)
- AC Line Monitor (E-ACLM-V/ -P)
- 5VDC Sensor Adapter (E-S5VDC)

For a complete list of available RS485 sensors supported, see page 135.

RS485 Sensor Management

The RS485 sensors are detected and identified by type automatically when they are connected to the RJ45 connector. The newly detected sensor will appear in the left menu of the web page under **Monitoring->Sensors**. A web page will be created for the sensor and the default name issued to the sensor by ENVIROMUX will be "**Undefined #n**", where n is the number of RJ45 connector from 1 to 16.

If a **multi-function sensor** is detected (i.e. E-STHSM/B), it will be displayed as multiple sensors, each one with a single function (as shown in Figure 32). For example a Temperature/Humidity/Dewpoint sensor will appear as separate sensors (Temperature sensor, Humidity sensor, and Dewpoint sensor) each with the same number connector. The default name of each sensor will be **Undefined #n**, where n is the connector. A multi-function sensor will be listed as a "Combo" type (i.e. Temperature Combo).

The user can see the sensor measurements by clicking on the sensor's name on the left menu or in the Summary page. A web page will be displayed for the selected sensor, showing the type of sensor, the name, value of the reading (if it is an analog value it will be also displayed graphically), the threshold settings (in red) and the current reading (in green) of a selected sensor. It also shows the time, date, and measurement taken of the most recent alert, statistics (last alert, lowest value, highest value) and a graph of the recorded values. Lowest and highest values are indicated only for RS485 sensors.

Note: In a cascaded configuration, only the sensors connected to the master unit will display graphs. To view the graph of a slave sensor you need to log into that slave unit directly.

If the sensor is removed or communication lost for any reason (example: cable disconnected) the unit will detect this and show the sensor in "Non Responding" status. Question marks (???) will replace the name in the summary list. In this way the user will know the sensor has a problem or as been accidentally disconnected. If the user wants to remove a sensor (including a sensor now replaced by question marks) from the summary list, it must be done manually by selecting **Delete** in the summary listing (see Figure 32 on page 31). If Delete is selected, a pop-up will appear confirming this selection before removal takes place.

Temperature 1 Status

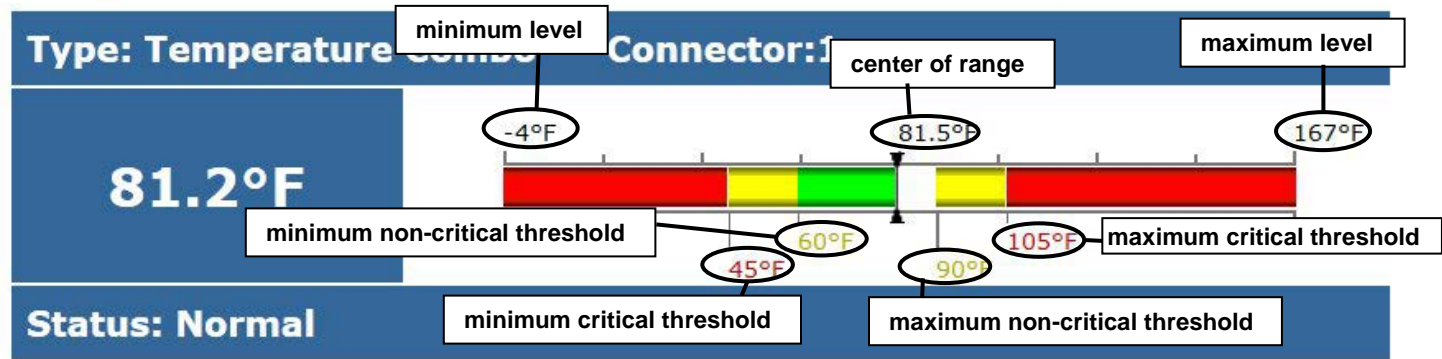

Handle Alert:

Last alert was at:	Never	N/A
Lowest Reading:	07-16-2012 10:23:43 AM	28.5
Highest Reading:	07-14-2013 11:06:08 PM	90.0

[Clear Records](#)

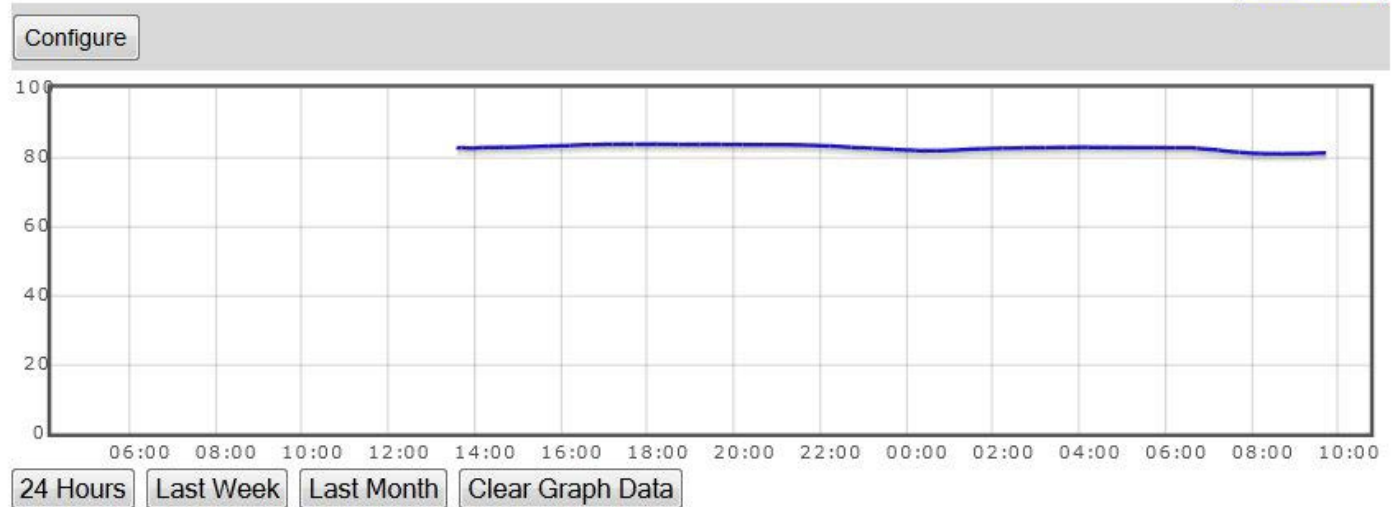

Figure 66 External Sensor Reading

If the sensor is in alert status, the user has the option to either **acknowledge** the alert or **dismiss** it. If the user acknowledges the alert, no additional alert messages will be sent during that alert status cycle. If the user dismisses the alert, another alert message will be sent once the “notify again after” time designated on the configuration page elapses.

The **Configure** button allows the user to configure parameters of the sensor.

When enabled, a graph that shows a history of a sensor’s readings is displayed (RS485, TACH and IP sensors only). The time period displayed can be changed to show the last hour, last week or last 30 days.

Note: If the ENVIROMUX is power-cycled, all history of sensor readings will be cleared.

Note: In a **cascaded configuration**, only the sensors connected to the master unit will display graphs. To view the graph of a slave sensor you need to log into that slave unit directly.

The range of readings displayed will adjust as the readings are taken. For example, in the above image, for the time period displayed the range of readings was between 82.2°F. to 80.2°F. As the readings vary and the time period increases, the range will automatically update to a wider range of temperatures and adjust the graph accordingly.

To clear the readings for a sensor and start over, click on **“Clear Graph Data”**. To disable the viewing of graphs, see page 76.

Note: If the sensor is a multi-function sensor (i.e. E-STHS), then using **“Clear Graph Data”** will clear the data for both the temperature and humidity readings of that sensor.

Sensor #2.1T Configuration (Type: Temperature)

Sensor Settings	
Description	<input type="text" value="Sensor #2.1T"/> Descriptive name for the sensor
Name in LED Display	<input checked="" type="checkbox"/> <input type="text"/> Optional name of the sensor as viewed in the LED Display(14 characters limit)
Units	<input type="text" value="Deg. C"/> <input type="button" value="v"/> Select the units for the sensor
Min. Level	<input type="text" value="-40.0"/> Min. supported value for the sensor
Max. Level	<input type="text" value="85.0"/> Max. supported value for the sensor
Min. Non-Critical Threshold	<input type="text" value="30.0"/> Min. threshold below which indicates a non-critical alert condition
Max. Non-Critical Threshold	<input type="text" value="45.0"/> Max. threshold above which indicates a non-critical alert condition
Min. Critical Threshold	<input type="text" value="10.0"/> Min. threshold below which indicates an alert condition
Max. Critical Threshold	<input type="text" value="50.0"/> Max. threshold above which indicates an alert condition
Enable Disconnection Alert	<input type="checkbox"/> Enable alert if not connected
Refresh Rate	<input type="text" value="10"/> <input type="button" value="Sec"/> <input type="button" value="v"/> The refresh rate at which the sensor view is updated
Enable Graph	<input checked="" type="checkbox"/> Enable graph for this sensor
Sensor Offset	<input type="text" value="0.0"/>  Value offset to correct ambient heating
Group Settings	
Group #01	<input checked="" type="checkbox"/> Sensor sends notifications for Group 1
Group #02	<input checked="" type="checkbox"/> Sensor sends notifications for Group 2
Group #03	<input checked="" type="checkbox"/> Sensor sends notifications for Group 3
Group #04	<input checked="" type="checkbox"/> Sensor sends notifications for Group 4
Group #05	<input checked="" type="checkbox"/> Sensor sends notifications for Group 5
Group #06	<input checked="" type="checkbox"/> Sensor sends notifications for Group 6
Group #07	<input checked="" type="checkbox"/> Sensor sends notifications for Group 7
Group #08	<input checked="" type="checkbox"/> Sensor sends notifications for Group 8

Sensor Offset is only available for the Temperature and Humidity sensors.

Figure 39- Sensor Configuration Page (1)

Schedule Settings																								
TIME DAY	AM											PM												
	0	1	2	3	4	5	6	7	8	9	10	11	12	13	14	15	16	17	18	19	20	21	22	23
SUNDAY																								
MONDAY																								
TUESDAY																								
WEDNESDAY																								
THURSDAY																								
FRIDAY																								
SATURDAY																								
HOLIDAY																								

On
 Partially On
 Off. Press and hold to select 15 min periods
 Reset

Non-Critical Alert Settings	
Disable Alerts	<input checked="" type="checkbox"/> Disable alert notifications for this sensor
Alert Delay	5 <input type="text"/> Sec <input type="button" value="v"/> Duration the sensor must be out of thresholds before alert is generated
Notify Again Time	6 <input type="text"/> Hr <input type="button" value="v"/> Time after which alert notifications will be sent again
Notify on return to normal	<input checked="" type="checkbox"/> Send a notification when this sensor returns to normal status
Enable Syslog Alerts	<input checked="" type="checkbox"/> Send alerts for this sensor via syslog
Enable SNMP Traps	<input type="checkbox"/> Send alerts for this sensor via SNMP traps
Enable E-mail Alerts	<input checked="" type="checkbox"/> Send alerts for this sensor via e-mail
E-mail Subject	E-16D-M Temperature 1 W Subject of e-mails sent for alerts
Enable SMS Alerts	<input type="checkbox"/> Send alerts for this sensor via SMS
Send custom SMS	<input type="checkbox"/> Replace standard SMS with a customized message
Customized SMS	<input type="text"/> Customized SMS message sent for alerts
Enable Siren	<input type="checkbox"/> Turn on the siren when this sensor goes to alert
Enable Beacon	<input type="checkbox"/> Turn on the beacon when this sensor goes to alert
Associated Output Relay	None <input type="button" value="v"/> Name of the output relay that can be controlled by this sensor
Output Relay status on alert	Inactive <input type="button" value="v"/> Status of the output relay when going to alert
Output Relay status on return from alert	Inactive <input type="button" value="v"/> Status of the output relay when returning from alert

Figure 40- Sensor Configuration Page (2)

Critical Alert Settings	
Disable Alerts	<input type="checkbox"/> Disable alert notifications for this sensor
Alert Delay	5 <input type="text"/> Sec <input type="button" value="v"/> Duration the sensor must be out of thresholds before alert is generated
Notify Again Time	6 <input type="text"/> Hr <input type="button" value="v"/> Time after which alert notifications will be sent again
Notify on return to normal	<input checked="" type="checkbox"/> Send a notification when this sensor returns to normal status
Auto acknowledge	<input checked="" type="checkbox"/> Automatically acknowledge alert when sensor returns to normal status
Enable Syslog Alerts	<input checked="" type="checkbox"/> Send alerts for this sensor via syslog
Enable SNMP Traps	<input checked="" type="checkbox"/> Send alerts for this sensor via SNMP traps
Enable E-mail Alerts	<input checked="" type="checkbox"/> Send alerts for this sensor via e-mail
E-mail Subject	E-16D-M Temperature 1 <input type="text"/> Subject of e-mails sent for alerts
Select IP Camera	Trendnet TV-IP672PI <input type="button" value="v"/> Select IP camera for image capture on alert
Attach IP camera capture to e-mail	<input type="checkbox"/> Attach captured image from selected IP camera to alert e-mail
Save image to USB	<input type="checkbox"/> Save captured image from selected IP camera to USB Flash
Enable SMS Alerts	<input checked="" type="checkbox"/> Send alerts for this sensor via SMS
Send custom SMS	<input type="checkbox"/> Replace standard SMS with a customized message
Customized SMS	<input type="text"/> Customized SMS message sent for alerts
Enable Siren	<input type="checkbox"/> Turn on the siren when this sensor goes to alert
Enable Beacon	<input type="checkbox"/> Turn on the beacon when this sensor goes to alert
Associated Output Relay	None <input type="button" value="v"/> Name of the output relay that can be controlled by this sensor
Output Relay status on alert	Inactive <input type="button" value="v"/> Status of the output relay when going to alert
Output Relay status on return from alert	Inactive <input type="button" value="v"/> Status of the output relay when returning from alert

When using SMS messaging, if special characters (other than English) are desired, in order to receive them via SMS, the language setting of the E-xD must be set to any language other than English (see Language Selection, page 73) -OR- Change the format in your modem settings from Plain Text to PDU (page 79) .

Attach image captured from an IP camera to include with alert sent via email.
This feature is available for all sensors connected to either the "RJ45 Sensor" ports or "Digital In" sensors.
See "Alert Notifications" on page 46 for more.

In E-5D, these are combined into one device option, to enable or disable the Siren/Beacon connected to the "Alarm" terminals on the E-5D.

This feature is not present in the E-2D.

Figure 41- Sensor Configuration Page (3)

The screenshot shows a web interface for sensor configuration. It is divided into two main sections: 'Data Logging' and 'Alert Simulation'.
 In the 'Data Logging' section, there is a checkbox labeled 'Add to data log' which is checked. Below it, the text reads 'Add readings to the data log'. There is a 'Logging Period' field set to '10' with a dropdown menu set to 'Sec'. Below this, it says 'Frequency at which readings are added to the data log.' A 'Save' button is located at the bottom of this section.
 The 'Alert Simulation' section is below and contains two buttons: 'Simulate Alert' and 'Clear Alert'.

Figure 42- Sensor Configuration Page (4)

External Sensor Configuration

Sensor Settings	Description
Description	The description of the sensor that will be viewed in the Summary page and in the body of alert messages
Name in LED Display	Place a checkmark in the box and enter a name up to 14 characters in length to be shown on an E-PLSD Programmable LED Sensor Display when one is connected. For installation and configuration of the E-PLSD, see man215.pdf .
Units	This lets the operator choose between Celsius and Fahrenheit as the temperature measurement unit.
Min. Level	Displays the minimum value that this sensor will report
Max. Level	Displays the maximum value that this sensor will report
Minimum Non-Critical - Threshold	The user must define the lowest acceptable value for the sensors. If the sensor measures a value below this threshold, the sensor will move to non-critical alert status. The assigned value should be <ul style="list-style-type: none"> ➤ within the range defined by Minimum Level and Maximum Level and ➤ lower than the assigned Maximum Threshold value. If values out of the range are entered, and error message will be shown.
Maximum Non-Critical Threshold	The user must define the highest acceptable value for the sensors. If the sensor measures a value above this threshold, the sensor will move to non-critical alert status. The assigned value should be <ul style="list-style-type: none"> ➤ within the range defined by Minimum Level and Maximum Level and ➤ higher than the assigned Minimum Threshold value. If values out of the range are entered, and error message will be shown.
Minimum Critical Threshold	The user must define the lowest acceptable value for the sensors. If the sensor measures a value below this threshold, the sensor will move to alert status. The assigned value should be <ul style="list-style-type: none"> ➤ within the range defined by Minimum Level and Maximum Level, ➤ lower than the assigned Maximum Threshold value, and ➤ lower than the Minimum Non-Critical Threshold value. If values out of the range are entered, and error message will be shown.
Maximum Critical Threshold	The user must define the highest acceptable value for the sensors. If the sensor measures a value above this threshold, the sensor will move to alert status. The assigned value should be <ul style="list-style-type: none"> ➤ within the range defined by Minimum Level and Maximum Level, ➤ higher than the assigned Minimum Threshold value, and ➤ higher than the Maximum Non-Critical Threshold value. If values out of the range are entered, and error message will be shown.
Enable Disconnection Alert	If this sensor is disconnected its status will change to alarm and an alert will be sent
Refresh Rate	Determines how often the displayed sensor value is refreshed on the Sensor page. A numeric value and a measurement unit (minimum 1 seconds, maximum 999 minutes) should be entered.
Enable Graph	Apply a checkmark if graphs are desired for this sensor. Up to 150 sensor graphs are supported. This is checked by default until 150 sensors or more are being monitored.
Sensor Offset	Apply a value, positive or negative, to compensate for the environmental influence on the sensor. For more, see page 37.

Group Settings	Description
Group	Assign the sensor to any or all groups 1 -8 (see also page 45) Note: Users intended to receive alerts from this sensor must be assigned to at least one of the selected groups.
Alert Settings (Applies to Critical and Non-Critical Alerts except where noted)	
Disable Alerts	Place a checkmark in the box to prevent alerts from being sent when this sensor's status changes Note: If alerts for a sensor are disabled, the associated output action (see "Outputs"- page 35) will still take place. There just won't be any alert notifications that this is occurring. For example, this might be used to turn ON a device, such as a fan, when the server room gets too warm, and OFF again when the temperature returns to normal. An alert message may not be desired under these circumstances. Note: if the user wants to disable alerts for a sensor after the sensor is already in alert status, the user must either acknowledge or dismiss the alert first.
Alert Delay	The alert delay is an amount of time the sensor must be in an alert condition before an alert is sent. This provides some protection against false alarms. The Alert Delay value can be set for 0-999 seconds or minutes. For more on alert delay, see "Alert Settings" on page 46)
Notify Again Time	Enter the amount of time in seconds, minutes, or hours (1-999) before an alert message will be repeated
Notify on Return to Normal	The user can also be notified when the sensor readings have returned to the normal range by selecting the " Notify when return to normal " box for a sensor.
Auto Acknowledge (Applies to Critical Alert settings only)	Place a checkmark in this box to have alert notifications in the summary page return to normal state automatically when sensor readings return to normal. Note: The Non-Critical alert settings do not have this option. Instead, non-critical alert notifications are always auto-acknowledged when sensor readings return to normal
Enable Syslog Alerts	Place a checkmark in this box to have alert notifications sent via Syslog messages
Enable SNMP traps	Place a checkmark in this box to have alert notifications sent via SNMP traps (v2c)
Enable Email Alerts	Place a checkmark in this box to have alert notifications sent via Email
Email Subject	Enter the subject to be viewed when an email alert message is received (up to 60 characters)
Attach IP Camera capture to email (Applies to Critical Alert settings only)	Associate a sensor with a IP camera. Select an IP camera from the drop-down box. An image will be captured and sent with the alert message when an alert is sent via e-mail. IP cameras that are monitored by the ENVIROMUX (page 66) will be available for this purpose. Note: If "Brief email" is enabled under User Settings (page 94) for a user, this setting will have no effect for that user. No images will be sent to that user.
Save Image to USB	Save the image captured by the IP Camera to the USB flash device when an alert is triggered
Enable SMS Alerts	Place a checkmark in this box to have alert notifications sent via SMS messages (requires a modem) or, see alternative method using User configuration on page 94
Send Custom SMS	Place a checkmark in this box to have a custom SMS message instead of using the standard SMS message
Customized SMS	Enter the customized SMS message (up to 160 characters) to be sent with an SMS Alert
Enable Siren	Turn ON the siren when this sensor goes to alert (not applicable to E-2D) Note: The Non-Critical alert settings do not have this option.
Enable Beacon	Turn ON the beacon when this sensor goes to alert (not applicable to E-2D) Note: The Non-Critical alert settings do not have this option.

Alert Settings (Applies to Critical and Non-Critical Alerts except where noted) (Cont'd)	
Associated Output Relay	<p>You can associate the sensor with the operation of the output relay, or not.</p> <p>By Default, the operation of an output relay can only be associated with one sensor or IP Device.</p> <p>To associate an output relay with more than one sensor or IP Device, place a checkmark in the checkbox under "System- Other Options- Disable Relay Interlock (page 76).</p> <p>Note: If the Output Relay is associated with a sensor/device, and configured to change state when a sensor crosses threshold into alert, it will change state even if the alerts are disabled.</p> <p>Note: Only one sensor/device should be associated with the Output Relay at a time. Contradicting commands from two or more sensors will result in the output relay responding to the state directed by the last command received.</p>
Output Relay Status on Alert	State the output relay will be in when sensor goes to an alert
Output Relay Status on Return from Alert	State the output relay will be in when sensor is no longer in alert
Data Logging	
Add to data log	This is a check-box that lets the user decide if the data sampled should be recorded in the Data Log.
Logging Period	Enter the time period between logged measurements

Be sure to press the **Save** button to save the configuration settings.

Groups

Groups are used to create a common relationship between sensors, IP devices, etc. and their alert messages. Each item being monitored can be assigned to one or more groups (up to 8 possible). Users (a maximum number of 17 including the root user) can receive alert messages from items in one or more groups (see user configuration on page 92).

Note: For a user to receive alerts for a sensor, both the user and the sensor configuration must have a common group number assigned.

Test Alerts

With all configuration settings completed, each sensor and how the ENVIROMUX will react to an alert condition can be tested. Press the **Simulate Alert** button at the bottom of the configuration page to test each of the notification methods configured. To cancel the simulation, press the **Clear** button.

Note: A simulated alert will test all settings including any delay that has been configured (i.e. if a 2 minute delay is configured, it will delay sending the email for 2 minutes)

To perform a test, the ENVIROMUX must be properly setup for a user to receive alert messages. Use the chart below to make sure the ENVIROMUX is setup properly.

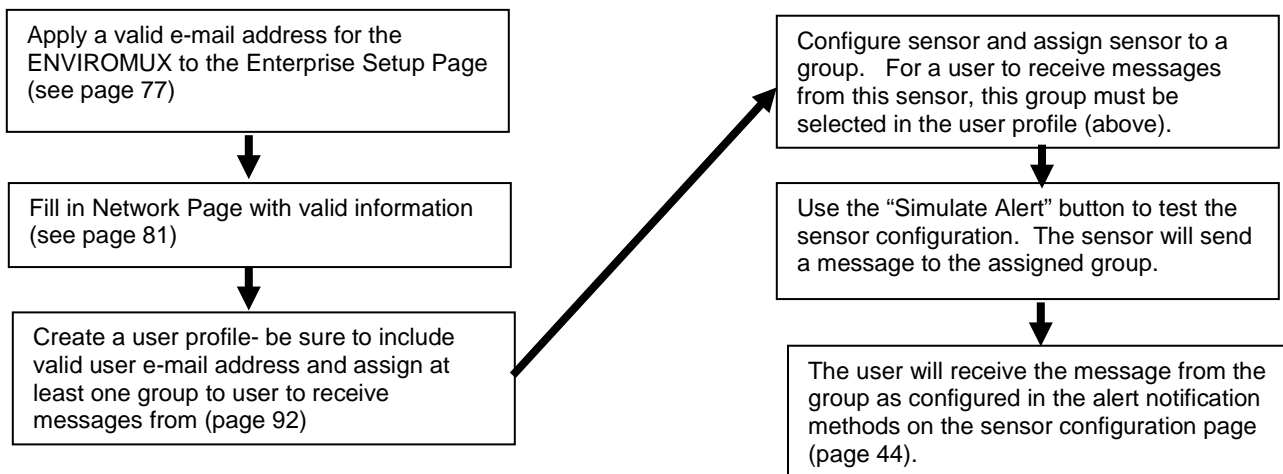

Figure 43- Chart to setup alert notification

Alert Settings

Alert Delay: The alert delay is an amount of time the sensor must be in an alert condition before an alert is sent. This provides some protection against false alarms. The Alert Delay value can be set for 0-999 seconds or minutes.

Example:

The maximum threshold of a temperature sensor is 90 F, and the temperature of the monitored area is fluctuating between 88 and 91 degrees:

Reading # (taken 1/ second)	Value	Action (with delay set @ 3 seconds)
1	88F	
2	89F	
3	90F	Ignored
4	89F	
5	90F	Ignored
6	89F	
7	90F	Ignored
8	90F	Ignored
9	90F	Alert sent
10	89F	

The sensor is in an alert condition in Reading 3 but is back within the acceptable range in Reading 4. At Reading 5, the sensor is in an alert condition again. Without the Alert Delay set, alerts will be sent for both Reading 3 and Reading 5. If the Alert Delay had been set to 3 seconds, an alert would only be sent if the sensor had made three consecutive readings in an alert condition (since readings are made every second). In this case, an alert will not be sent until Reading 9.

Alert Notifications

The alert can be configured to notify one or more users via e-mail, SNMP traps (v1,v2c,v3), Syslog messages, or SMS alerts. The e-mail subject line for e-mail notification can be customized for easy source identification. The alert can activate an audible siren, or an alarm beacon. Alerts are also indicated on the "Int Alert" or "Ext Alert " LEDs on the front of the ENVIROMUX and in the WEB interface.

External sensors have the added feature of being able to be associated with an IP camera. If a checkmark is added to the block "Attach IP camera capture to email" and an IP camera is selected from the drop-down box, an image will be captured and sent with the alert message when an alert is sent via e-mail. IP cameras that are monitored by the ENVIROMUX (page 66) will be available for this purpose.

Note: To be able to send IP camera captures as e-mail attachments, viewer security (in your camera's configuration) needs to be disabled. Consult your IP camera manual to see if this feature is present and for instructions on how to do this.

If a checkmark is added to "Save Image to USB", the image captured by the IP camera will also be saved to a flash drive connected to a USB port.

Thresholds

Minimum Threshold: The user must define the lowest acceptable value for the sensors. If the sensor measures a value below this threshold, the sensor will move to alert status. The assigned value should be within the range defined by Minimum Level and Maximum Level and lower than the assigned Maximum Threshold value. If values out of the range are entered, they will be automatically adjusted to be within range.

Maximum Threshold: The user must define the highest acceptable value for the sensors. If the sensor measures a value above this threshold, the sensor will move to alert status. The assigned value should be within the range defined by Minimum Level and Maximum Level and higher than the assigned Minimum Threshold value. If values out of the range are entered, they will be automatically adjusted to be within range.

Outputs

Each sensor can be associated with one of the connections labeled "Output Relays" (see page 23), and that connection can be set to open or close the contacts of the relay either on alert, or when returning to normal. The tamper can also block the output command generated by the alert. In this way other devices can be controlled by sensor and tamper alerts.

Schedule Settings

The Schedule Settings section provides the user with extensive control over the days and times that alert messages will be sent by a sensor. Time periods are in the 24HR format starting with 0 (12:00 to 1:00 a.m.) and each day of the week can be defined separately. Additionally, an extra control is provided for separate scheduling to occur on holidays, defined under System Configuration (page 73). By default, all timer periods are enabled.

TIME DAY	AM												PM											
	0	1	2	3	4	5	6	7	8	9	10	11	12	13	14	15	16	17	18	19	20	21	22	23
SUNDAY	On	On	On	On	On	On	On	On	On	On	On	On	On	On	On	On	On	On	On	On	On	On	On	On
MONDAY	On	On	On	On	On	On	On	On	On	On	On	On	On	On	On	On	On	On	On	On	On	On	On	On
TUESDAY	On	On	On	On	On	On	On	On	On	On	On	On	On	On	On	On	On	On	On	On	On	On	On	On
WEDNESDAY	On	On	On	On	On	On	On	On	On	On	On	On	On	On	On	On	On	On	On	On	On	On	On	On
THURSDAY	On	On	On	On	On	On	On	On	On	On	On	On	On	On	On	On	On	On	On	On	On	On	On	On
FRIDAY	On	On	On	On	On	On	On	On	On	On	On	On	On	On	On	On	On	On	On	On	On	On	On	On
SATURDAY	On	On	On	On	On	On	On	On	On	On	On	On	On	On	On	On	On	On	On	On	On	On	On	On
HOLIDAY	On	On	On	On	On	On	On	On	On	On	On	On	On	On	On	On	On	On	On	On	On	On	On	On

On
 Partially On
 Off. Press and hold to select 15 min periods
 Reset

Figure 44- Schedule Settings for alerts

Dark green blocks indicate time periods when an alert messages are enabled to be sent to all users as it has been configured to do so.

White blocks indicate time periods where messages are disabled and no alert messages will be sent by that sensor.

Light green blocks indicated time periods where part of that hour is configured to send alerts, and part of it is configured to not send alerts.

TIME DAY	AM												PM											
	0	1	2	3	4	5	6	7	8	9	10	11	12	13	14	15	16	17	18	19	20	21	22	23
SUNDAY	On	On	On	On	On	On	On	On	On	On	On	On	On	On	On	On	On	On	On	On	On	On	On	On
MONDAY	On	On	On	On	On	On	On	On	On	On	On	On	On	On	On	On	On	On	On	On	On	On	On	On
TUESDAY	On	On	On	On	On	On	Light	Light	Light	Light	Light	Light	On	On	On	On	On	On	On	On	On	On	On	On
WEDNESDAY	On	On	On	On	On	On	Light	Light	Light	Light	Light	Light	On	On	On	On	On	On	On	On	On	On	On	On
THURSDAY	On	On	On	On	On	On	Light	Light	Light	Light	Light	Light	On	On	On	On	On	On	On	On	On	On	On	On
FRIDAY	On	On	On	On	On	On	On	On	On	On	On	On	On	On	On	On	On	On	On	On	On	On	On	On
SATURDAY	On	On	On	On	On	On	On	On	On	On	On	On	On	On	On	On	On	On	On	On	On	On	On	On
HOLIDAY	On	On	On	On	On	On	On	On	On	On	On	On	On	On	On	On	On	On	On	On	On	On	On	On

On
 Partially On
 Off. Press and hold to select 15 min periods
 Reset

Figure 45- Colored blocks indicate variations in settings

To disable alerts for the entire hour, simply click on the block. To change it back, click it again.

To disable alerts for several hours, click and drag several blocks in either direction (left-to-right for over the same day, or up-and-down for the same hour over several days). Click and drag again to change it back.

Be sure to click "Save" at the bottom of the page to save your changes before leaving this page.

If you leave the page without saving, no changes will be saved.

To Disable alerts for a sensor for the whole day with one click, just click on the day of the week.

Click here to toggle change for the whole day

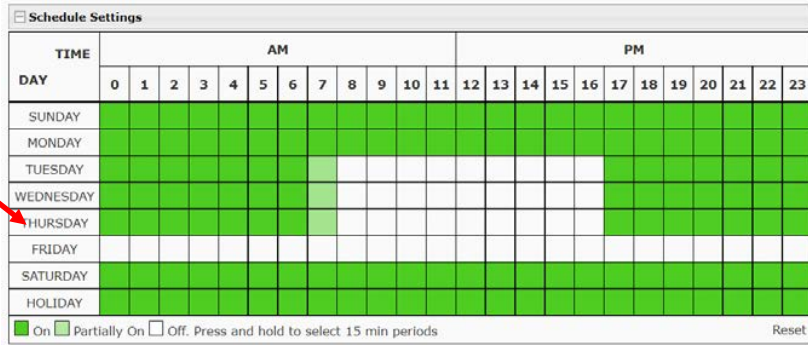

Figure 46- Disable alerts for an entire day

Or for the same hour in the entire schedule, just click on the hour of the day.

Click here to toggle change for the whole hour each day

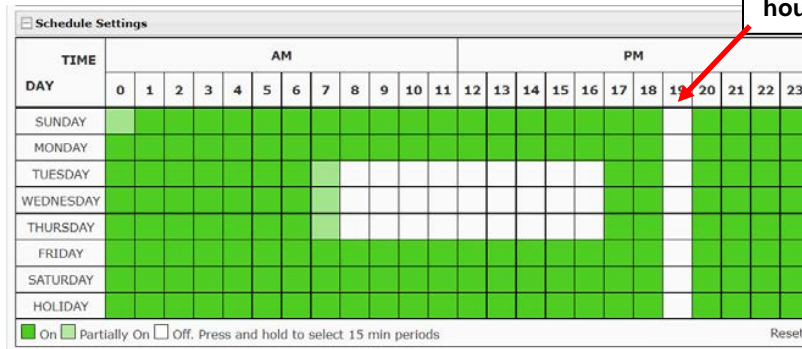

Figure 47- Disable alerts for the same hour every day

To control the time period down to 15 minute increments (turning the block light green), click and hold a block. Then select the 15 minute period(s) where alerts will be enabled vs. disabled for that sensor.

Light green indicates only part of the hour has been changed

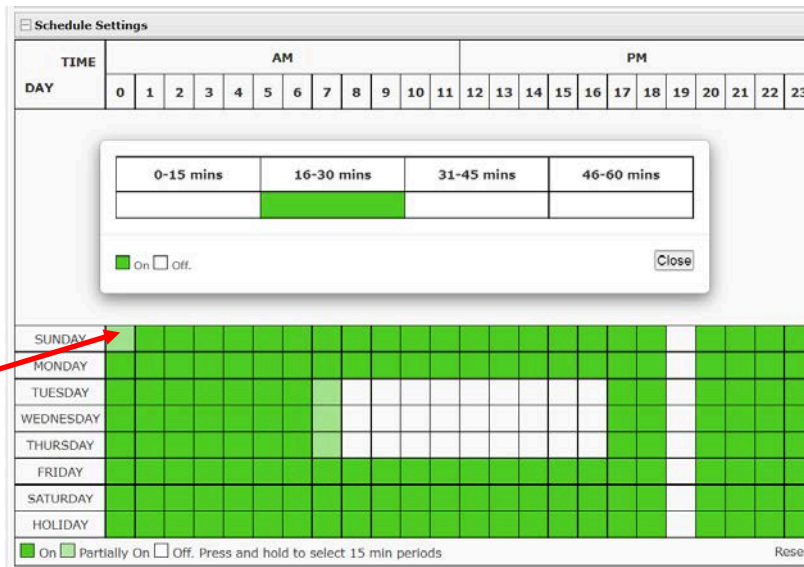

Figure 48- Select 15 minute increments of control over alerts

Be sure to click "Save" at the bottom of the page to save your changes before leaving this page.

If you leave the page without saving, no changes will be saved.

Specialized Sensors (for E-S420MA-24V Current Sensor Configuration only)

When a E-S420MA-24V Current Sensor is connected to the ENVIROMUX, the summary page will update with two sensor names of the Type "Current". Various types of sensors can be connected to an E-S420MA-24V. In order to better define the sensor on the Summary Page, in SNMP traps, or in an MIB browser, click on the "Edit" link to open the sensor configuration page and configure the sensor. In the image below, an E-ULT Ultrasonic Level Transmitter has been connected to the Current Sensor plugged into RJ45 port 3 and configured to be used.

Summary (alerts detected), (events triggered)

Internal Sensors					
No.	Description	Type	Value	Status	Action
1	Internal Temperature	Temperature	0.0°C	Alarm	View Edit
2	Internal Humidity	Humidity	Out of range	Alarm	View Edit
3	Battery	Voltage	13.9V	Normal	View Edit

Sensors					
Conn.	Description	Type	Value	Status	Action
	Sensor #1.1	Water	Open	Normal	View Edit Delete
	Sensor #2.1	Temperature Combo	76.5°F	Alarm	View Edit Delete
	Sensor #2.2	Humidity Combo	Out of range	Alarm	View Edit Delete
	Sensor 10	Fluid Level	20 Inch	Normal	View Edit Delete
	Sensor #3.2	Current	0.0mA	Alarm	View Edit Delete

An E-ULT sensor is connected to one input on the current sensor, the second input has not been configured.

Select "Edit" to configure

Figure 49- Current sensor added to ENVIROMUX

Sensor 10 Configuration

Sensor Settings

Description
Descriptive name for the sensor

Group
Select which group the sensor belongs to

Min. Level
Min. supported value for the sensor

Max. Level
Max. supported value for the sensor

Associate Sensor
Associate sensor to a customized sensor type

Associated Sensor Type
Type of the associated sensor

Associated Sensor Unit
Measurement unit for the associated sensor

SNMP Associated Type ID
ID value for SNMP type of associated sensor

Min. Associated Level
Sensor expected value corresponding to 4mA

Max. Associated Level
Sensor expected value corresponding to 20mA

Min. Non-Critical Threshold
Min. threshold below which indicates a non-critical alert condition

Max. Non-Critical Threshold
Max. threshold above which indicates a non-critical alert condition

Min. Critical Threshold
Min. threshold below which indicates an alert condition

Max. Critical Threshold
Max. threshold above which indicates an alert condition

Refresh Rate
The refresh rate at which the sensor view is updated

Non-Critical Alert Settings

Critical Alert Settings

Data Logging

Figure 50- Configuration of sensor connected to E-S420MA-24V

Most of the sensor settings are the same as any other sensor configuration (page 43) but there are some differences:

Sensor Settings	Description
Associate Sensor	Select if the Type "Current" should be replaced by the sensor type to be entered in the next box
Associated Sensor Type	Enter the "Type" of sensor that should be displayed on the summary page and in all alert communications received regarding this sensor
Associated Sensor Unit	Enter between 1 and 3 alphabetical characters. These characters will be used by the ENVIROMUX to represent the unit of measure reported by the attached sensor. Leaving it empty will result in an empty string in the reported data.
SNMP Associated Type ID	Enter ID value from MIB file if SNMP traps will be used for alert notifications for this sensor (for more on this, see "SNMP Custom Type ID" below)
Min. Associated Level	The minimum range of the units to be associated with the current reading measured from the attached sensor.
Max. Associated Level	The maximum range of the units to be associated with the current reading measured from the attached sensor.

SNMP Custom Type ID: Use this field if SNMP traps will be used for alert notifications. The Type ID corresponds with a value defined in the MIB file under "extSensorType" (default value is 32767 for type "Custom"). Place the desired number in this box that represents the type of sensor to be reported in the MIB browser or SNMP trap.

To define a new type of sensor;

1. open the MIB file,
2. locate the section titled "extSensorType",
3. assign a description and a number not already in use (in the "SYNTAX" field) to associate with it ,
4. enter the number for the newly defined extSensorType in the SNMP Custom Type ID box.

If the Type ID is left blank, the value "0" will be assigned, which will be reported in the browser and SNMP trap as type "undefined".

Contact Sensors

Contact Sensors are sensors that close or open a contact according to the sensor condition. Their presence and their type cannot be automatically detected by the RJ45 Sensor port. The sensors have to be manually added to the unit list by the administrator or a user with administrator privileges. Contact sensors can be either connected to RJ45 Sensor ports, or more commonly to Digital Input terminals.

Add a Contact Sensor to RJ45 Sensor port

When adding a contact sensor to an RJ45 Sensor port, after connecting the sensor to an available port, the administrator must select "Add New Sensor" at the bottom of the **Monitoring->Sensors** page.

Sensors

Internal Sensors					
No.	Description	Type	Value	Status	Action
1	Internal Temperature	Temperature	27.3°C	Normal	View Edit
2	Internal Humidity	Humidity	41%	Normal	View Edit
3	Battery	Voltage	13.4V	Normal	View Edit

Sensors					
Conn.	Description	Type	Value	Status	Action
1	Temperature 1	Temperature Combo	84.0°F	Normal	View Edit Delete
1	Humidity 1	Humidity Combo	37%	Normal	View Edit Delete
1	Dew Point Sensor 1	Dew Point	54.7°F	Normal	View Edit Delete
2	Light Sensor 2	Light	51.7lx	Normal	View Edit Delete
3	Temperature 3	Temperature	81.8°F	Normal	View Edit Delete
4	Humidity 4	Humidity	36%	Normal	View Edit Delete
5	Temperature 5	Temperature Combo	28.2°C	Normal	View Edit Delete
5	Humidity 5	Humidity Combo	38%	Normal	View Edit Delete
6	Sensor #6.1	ACLM-V AC Voltage	120.0V	Normal	View Edit Delete
6	Sensor #6.2	ACLM-V AC Voltage	120.0V	Normal	View Edit Delete
8	Water Detection Sensor 8	Water	Open	Normal	View Edit Delete
16	Motion Detector 16	Motion Detector	Closed	Normal	View Edit Delete
	Wind Speed on E-160	Wind Speed	0.0MPH	Acknowledged	View Edit Delete

[Add New Sensor](#)
[Add Tach Sensor on Digital input 1](#)

To install a tachometer type sensor (like the Wind Speed sensor above), connect it to Digital In 1 and click this link for a configuration page with extra settings for specialized sensors (page 49).

Figure 51- List of sensors

In the Add Sensor page, enter the type of sensor and the RJ45 connector where the sensor is connected. Then select "Add". If the connector was already in use and has a sensor already defined for it, an error message will be displayed at the bottom of the Summary page.

Add New Sensor

[-] Add New Sensor

Sensor Type	<div style="border: 1px solid #ccc; padding: 2px; display: inline-block;">Water</div> <small>Select the sensor type</small>
RJ45 Connector	<div style="border: 1px solid #ccc; padding: 2px; display: inline-block;">8</div> <small>Choose which RJ45 jack the sensor will be connected to</small>

Figure 52- Add a contact sensor

Many of the settings found in the RS485 configuration page are not present because they do not apply to contact sensors. As such, only “Critical Alert Settings” apply (see descriptions on page 43) and non-critical alert settings are omitted altogether. A setting that is present only for contact sensors connected to RJ45 sensor ports and for Digital Input sensors (page 54) is “Change Global Alert Status on triggering this sensor” (explained on page 53).

New Sensor Configuration (Type: New Sensor)

[-] Sensor Settings	
Description	Sensor #5.1 Descriptive name for the sensor
Normal Status	Open Select the normal status for the sensor
Enable Tamper Alert	<input type="checkbox"/> Enable tamper alert notifications for this sensor
Tamper Normal Status	Closed Select the tamper contact normal status
State Open	Open Descriptive name for open state
State Close	Closed Descriptive name for close state
Refresh Rate	10 Sec The refresh rate at which the sensor view is updated
[+] Group Settings	
[+] Schedule Settings	
[+] Critical Alert Settings	
[+] Data Logging	
Save	
Alert Simulation	
Simulate Alert Clear Alert	

Figure 53- Contact Sensor configuration page

Aside from the usual Description, Group, and Refresh Rate settings to be applied, the configuration page introduces four new settings:

Normal Status: This will be the contact sensors state when it is not in alert, either with contact closed, or contact open.

Enable Tamper Alert: If the contact sensor has a tamper feature, and the feature is being connected to the ENVIROMUX, then this box can be selected if alert messages are desired in the event the contact sensor tamper feature’s state changes from its defined “Normal Status”.

Tamper Normal Status: This will be the normal state of the contact sensor’s tamper feature when not being tampered with.

State Open/Close: Customize the information that will be provided to you in an alert message (up to 32 characters) and in the status on the Summary page when the state changes.

Change Global Alert Status on triggering this sensor: Found under Critical Alert Settings, this feature enables the user to configure this sensor to cause the following changes to take effect:

- A) **No Alert Changes:** make no changes to how alerts are managed (the default setting)
- B) **Enable Global Alerts:** force all alert settings in effect to be acted upon as configured (if another sensor has disabled alerts, this setting will re-enable them). An alert message will be sent to all configured users to indicate this has occurred.

Note: This will not enable sensor alerts for those sensors that have "Disable Alerts" checked.

- C) **Disable Global Alerts:** disable all alerts from being sent throughout the ENVIROMUX - when this sensor state changes, all alert communications from all sensors connected to this ENVIROMUX **will be disabled**. An alert message will be sent to all configured users to indicate this has occurred. When disabled, the message "Global Alerts are currently disabled" will be displayed in red at the top of the Summary and Alert Information pages.

Note: If one contact sensor is configured to disable global alerts, it is recommended to configure another contact sensor to enable global alerts. Otherwise, once disabled, global alerts will remain disabled indefinitely, or until global alerts are manually re-enabled by using the "Enable Global Alerts" button on the Alarm Summary page (page 36).

An example for configuring this feature is found in "[Using Disable/Enable Global Alerts Feature](#)".

The screenshot shows the 'Alert Settings' configuration page. The 'Change Global Alert Status on triggering this sensor' dropdown menu is open, showing three options: 'No Alert Changes', 'Enable Global Alerts', and 'Disable Global Alerts'. A callout box with an arrow points to the 'No Alert Changes' option, containing the text 'Use this setting very carefully!'.

Figure 54- Contact and Digital Alert Settings

Digital Inputs

The “Digital In” terminals (page 12) are for easy installation of contact sensors (as opposed to using the RJ45 sensor ports). Connect up to 8 different contact sensors having either 2-wire contacts (for open or closed circuit sensing) or 4-wire contacts (for open or closed circuit sensors requiring 12V power supplies to operate). Therefore, the field “Normal Status” is provided to select the status of the sensor when it is not in an alert state. Select between **Open** contacts, or **Closed** contacts for the normal status of the sensor. (Water sensors are open contact when not in alert state.)

Note: The E-5D/2D have room for only 5 contact sensors, and do not provide 12V power to them individually.

An “Aux Pwr” terminal is available for up to 500mA of sensor support.

Before Digital Inputs will be listed in the Summary page or Digital Input page, they must first be added on the Digital Input page using “Add New Digital Input” (shown in image below).

Digital Input Sensors

Digital Inputs					
Conn.	Description	Type	Value	Status	Action
2	Digital Input 2 ACVD	Digital Input	Open	Acknowledged	View Edit Delete

[Add New Digital Input](#)
[Add New ENVIROMUX-SDA Sensor](#)

This link is for adding the E-SDA Smoke detector **only**.
 For all other smoke detectors use “Add New Digital Input”

Remote Digital Inputs					
Conn.	Description	Type	Value	Status	Action
11.2	Conn 11 Digital Input 2	Digital Input	Open	Normal	View Edit Delete

[Add New Remote Digital Input](#)

Remote Digital Inputs are Digital Inputs connected to an E-DI16DO(R)16 Digital Input Expander (sold separately)

Figure 55- Digital Input Sensors

First, select a connector on the ENVIROMUX that you wish to view the status of.

Add New Digital Input

[-] Add New Digital Input

Connector 2 ▾

Choose which connector the digital input will be connected to

Add

2 ▾

2

3

4

5

6

7

8

Figure 56- Select connector on ENVIROMUX

Once the connector is selected, a configuration window will open providing fields for the additional information available to setup the sensor.

Digital Input Configuration

Digital Input Settings

Description: E-5DEL Water Level Sensor
Descriptive name for the digital input

Normal Status: Open
Select the normal status for the digital input

Refresh Rate: 1 Sec
The refresh rate at which the digital input view is updated

State Open: No Water
Descriptive name for open state

State Close: Water Detected
Descriptive name for close state

Tip: To test a Digital Input sensor, after the input and alert settings have been properly configured, change the Normal Status to the opposite of what "Normal" is, and click Save. This should cause the sensor to go into alert and test all communication methods that have been configured. Be sure to change the Normal Status back when the test is complete.

Note: The "Normal Status" of the contact sensor must be set to either open or closed, depending on the contact position of the sensor connected to it. If the sensor connected has a normally-closed switch position at rest, the Normal Status should be set to "Closed". If the connected sensor has a normally-open switch position at rest, the Normal Status should be set to "Open".

The Descriptive name provided here will be displayed on the Summary page and in alert communications when the state of this sensor changes.

Save

Alert Simulation

Simulate Alert Clear Alert

Figure 57- Configure New Sensor

After the Digital Input sensor has been installed, the management and configuration of it is similar to Contact Sensors (page 51). To view the status of a sensor, click on the sensor as listed in the Digital Input page (Figure 55).

Digital Input #2 Status

Type: Digital Input Connector:2

Open

Status: Normal

Handle Alert: Dismiss Apply Changes

Last alert was at: Never [Clear Records](#)

[Cycle Sensor Power](#)

[Configure](#)

Cycle Sensor Power

Open configuration page

Figure 58- Status of Digital Input #2

To adjust configuration of an existing sensor, click on "Configure". The configuration window can also be opened by clicking on "Edit" in the Digital Input page.

Digital Input Sensors

Conn.	Description	Type	Value	Status	Action
1	Digital Input #1	Digital Input	Open	Normal	View Edit Delete
3	Digital Input #3	Digital Input	Open	Normal	View Edit Delete

Open configuration page

Figure 59- Open configuration from Digital Input page

Cycle Sensor Power

A "Cycle Sensor Power" button is also provided (see Figure 58) for each sensor connected to the "Digital In" terminals (locally-connected Digital Inputs only). To momentarily disrupt power to any sensor connected to a Digital Input terminal, click on this button. For example, when a smoke detector needs to be power-cycled in order to reset it. The 12VDC power will be disrupted to the sensor for 5 seconds and then automatically restored.

Note: On E-5D and -2D, the "Cycle Sensor Power" will cause the "AUX PWR" terminals to cycle power. This will only be effective for the sensor you are clicking the button for if that sensor is being powered from these terminals. If your sensor is powered, for example, from an AC adapter, the "Cycle Sensor Power" button will have no effect on that sensor, but it will still cycle power on the "AUX PWR" terminals, disrupting any device getting power from these terminals for 5 seconds. Keep this in mind if more than one sensor (or device) is being powered from these terminals.

To test your Digital Input configuration, click on "Configure" (Figure 58) for the sensor, and click on "Simulate Alert" (Figure 57). Now go to the Summary Page. The Status for that sensor should now show it to be in "Alarm" (provided your Alert Delay, under Alert Settings, is not set for too many seconds). If the Alert Delay is in play, you will have to wait for that time to expire before the Status will change.

Digital Inputs					
Conn.	Description	Type	Value	Status	Action
2	E-16D-M ACVD DI2	Digital Input	Closed	Normal	View Edit Delete
3	E-16D-M Test Switch DI3	Digital Input	Open	Alarm	View Edit Delete
5	E-16D-M Digital Input 5	Digital Input	Open	Alarm	View Edit Delete
S1-2	E-16D-S1 DI 2	Digital Input	Open	Normal	View Edit Delete
S1-8	E-16D S1 Digital Input 8	Digital Input	Open	Normal	View Edit Delete

Add Tach Sensor

To add a Tach Sensor, make connections of the tachometer type sensor (ENVIROMU-WSS for example) to Digital Input 1 on the rear of the ENVIROMUX. Then select "Add Tach Sensor on Digital Input 1" on the Sensors summary page (page 51). The sensor configuration page with added settings for a custom sensor will appear. These settings are the same as those described under "Specialized Sensors" on page 49. This special purpose of Digital Input 1 can be used by any device that produces a frequency up to 255Hz.

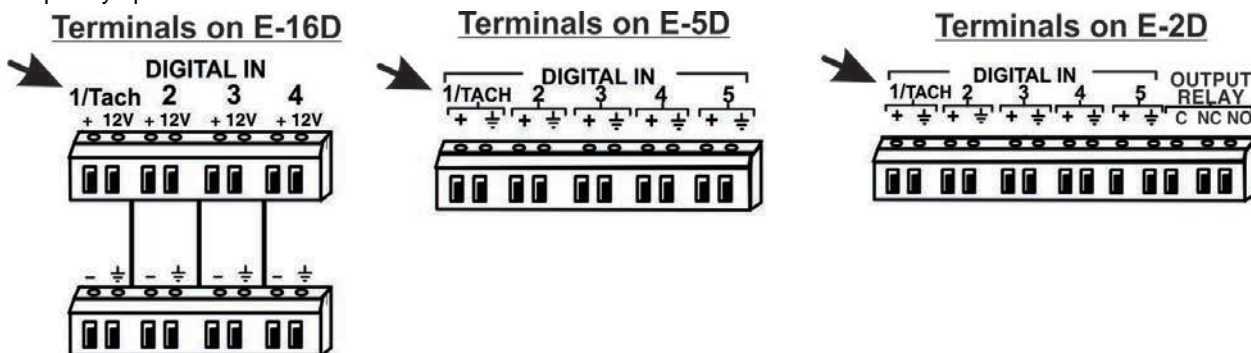

Figure 60- Connection that supports Tachometer Sensor

Note: Digital Input 1 is the only terminal connection point that supports a tach sensor.

To remove a digital input sensor from the displayed list, click on "Delete" under the Action column in the Digital Input Sensor list.

Monitor Output Relay

Output relays are provided to control external devices with a rating of up to 1A, 30VDC or 0.5A, 125VAC. Each relay state is monitored to be either inactive (relay is at rest; contacts as indicated by product markings) or active (relay is energized; contacts are opposite that of product markings). The status of the relay can be changed either manually through the web interface, or as a result of an alert (page 44).

Remote Output Relays are those located on E-DI16DO(R)16 Digital Input/Output Expanders and are configured in the same way as Output Relays on the E-xD. See the manual for the E-DI16DO(R)16 for more.

Output Relays

Output Relays					
Conn.	Description	Type	Value	Status	Action
1	Output Relay #1	Output Relay	Inactive		View Edit
2	Output Relay #2	Output Relay	Inactive		View Edit
3	Output Relay #3	Output Relay	Inactive		View Edit
4	Output Relay #4	Output Relay	Inactive		View Edit

Click "View"

Figure 61- Monitoring Output Relays

Output Relay #2 Status

Type Output Relay

Inactive

Set Output:: Deactivate ▾ Apply Changes

Configure

Click "Configure" →

Figure 62- Output Relay Status

To test your connections and set the state of the relay manually, from the relay status page (Figure 62), select the arrow next to Set Output to drop down the window and select either "Deactivate" or "Activate". Then click the "Apply Changes" button.

The relay state can also be changed using SNMP. See page 83 for details.

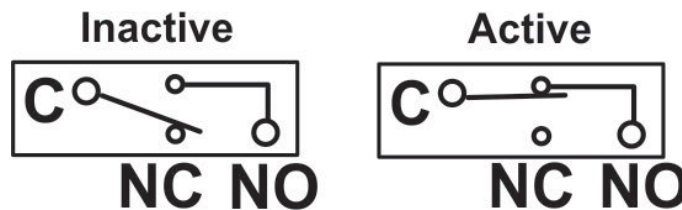

Figure 63- Output Relay Contact State

To change settings for the output relay and whether or not a state change should generate an alert message, click the “Configure” button.

Output Relay Configuration

Output Relay Settings	
Description	E-16D-S1 Output Relay Descriptive name for the output relay
Normal Status	Inactive Select the normal status for the output relay
State Active	E-16D-S1 Output Relay Descriptive name for active state
State Inactive	E-16D-S1 Output Relay Descriptive name for inactive state
Group Settings	
Logs	<input checked="" type="checkbox"/> Sensor sends notifications for Group 1
Internal Sensors	<input type="checkbox"/> Sensor sends notifications for Group 2
External Sensors	<input type="checkbox"/> Sensor sends notifications for Group 3
Digital Inputs	<input type="checkbox"/> Sensor sends notifications for Group 4
IP Devices	<input type="checkbox"/> Sensor sends notifications for Group 5
IP Sensors	<input type="checkbox"/> Sensor sends notifications for Group 6
Output Relays	<input type="checkbox"/> Sensor sends notifications for Group 7
Power Supplies	<input type="checkbox"/> Sensor sends notifications for Group 8
Alert when status is changed	
Enable Syslog Alerts	<input checked="" type="checkbox"/> Send alerts for this output relay via syslog
Enable SNMP Traps	<input type="checkbox"/> Send alerts for this output relay via SNMP traps
Enable E-mail Alerts	<input checked="" type="checkbox"/> Send alerts for this output relay via e-mail
E-mail Subject	E-16D-M Output Relay 1 Ac Subject of e-mails sent for alerts
Enable SMS Alerts	<input type="checkbox"/> Send alerts for this output relay via SMS
<input type="button" value="Save"/>	

These names are just names assigned under “Group Names” (page 101) and have no other specific association.

When using SMS messaging, if special characters (other than English) are desired, in order to receive them via SMS, the modem SMS format must be set to PDU (see page 79)

Figure 64- Configure Output Relay

From the configuration page, the user can apply a description of the relay that will be used on the summary page and in any alert messages sent, if so configured.

Choose the Normal Status for the relay, between Inactive or Active. When the status changes from what is defined as “normal”, an alert will be sent if so configured.

To have messages sent to specific members, select the monitoring group(s) the relay will belong to.

When the relay is in an alert state, the ENVIROMUX can be configured to send an email, syslog and SMS alerts, as well as an SNMP trap to the users subscribing to alerts in the selected group. Place a checkmark in the box for those features you wish to enable.

If email alerts is enabled, enter an e-mail subject line that will get the attention of the recipient(s).

Note: When the ENVIROMUX is powered OFF with the battery completely drained, each relay will revert to an inactive state, regardless of the “Normal Status” setting.

Once configured, output relays are controlled by their associated sensor and can be programmed to change state (from normally-open to normally-closed or vice versa) on an alert or on the return to normal conditions. Programming is done on the configuration page of the associated sensor or Smart Alert. Each output relay can be associated with any one sensor or Smart Alert.

IP Devices

Up to 64 IP addresses can be assigned to be monitored by ENVIROMUX. They will be displayed under the **Monitoring->IP Devices** item in the left side menu. The ENVIROMUX will periodically ping (test) these addresses to determine whether or not they are up and running. If the address is not running, an alert will be recorded.

For each device the user can configure the

- * IP address,
- * the name,
- * the sensor group the IP device will belong to
- * the ping period (period of time between two consecutive tests),
- * the time-out period (in seconds) in which the address should respond
- * the number of times the ENVIROMUX should ping the address before reporting an alert
- * how often, if at all, the reading taken should be added to the data log.

If the address fails to respond within the time-out for the selected number of times it will generate an alert. It will be tested again after the programmed period of time.

Just as with other sensors, the method of alert notification and the effect, if any, on output contacts can be configured in response to IP address connection failures.

IP Devices

IP Devices					
No.	Description	Type	Value	Status	Action
1	Test	IP Device	Responding	Normal	View Edit Delete
2	Test2	IP Device	Not Responding	Alarm	View Edit Delete
3	test3	IP Device	Responding	Alarm	View Edit Delete

[Add New IP Device](#)

Figure 65- IP Devices monitored

To add an IP device to monitor, select “Add New IP Device” from the **Monitoring ->IP Devices** page.

Add New IP Device

[-] Add New IP Device

Description	<input type="text"/>
	Descriptive name for the IP Device
IP Address	<input type="text"/>
	IP Address of the device to ping

Figure 66- Add new IP Device

Apply a descriptive name for the IP Device to be monitored, and the IP address of the device.

IP Device Configuration

IP Device Settings

Description	<input type="text" value="DNS Server"/>	<small>Descriptive name for the IP Device</small>
IP Address	<input type="text" value="192.168.1.52"/>	<small>IP Address of the device to ping</small>
Ping Period	<input type="text" value="2"/> <input type="button" value="Min"/> ▾	<small>The frequency at which to ping the device</small>
Timeout	<input type="text" value="2"/>	<small>Duration, in seconds, to wait for a response to a ping</small>
Retries	<input type="text" value="10"/>	<small>The number of tries before device is considered in alarm</small>

Group Settings

Schedule Settings

Alert Settings

Data Logging

Alert Simulation

Figure 67- IP Device Configuration

IP Device Settings	Description
Description	The description of the IP Device that will be viewed in the Summary page and in the body of alert messages
IP Address	The IP address of the IP Device
Ping Period	Enter the frequency in minutes or seconds that the ENVIROMUX should ping the IP Device
Timeout	Enter the length of time in seconds to wait for a response to a ping before considering the attempt a failure
Retries	Enter the number of times the ENVIROMUX should ping a non-responsive IP device before changing its status from normal to alarm and sending an alert

There is no limit to the number of times you can retry to ping (retries), how long to wait for a response (timeout), or how long you can set it to wait between pings to a device(ping period). These values are up to you.

Under Group Settings, place a checkmark for each group that alert messages should be assigned to. This will determine who will receive an alert due to a ping failure.

IP Device Configuration

+ IP Device Settings

+ Group Settings

- Schedule Settings

Schedule Type	<input type="text" value="Always active"/>	Configure the device's schedule type
Start Day	<input type="text" value="Sun"/>	First day of the week when the device is active
End Day	<input type="text" value="Sun"/>	Last day of the week when the device is active
Start Hour	<input type="text" value="00:00"/>	Starting hour for the device's daily schedule
End Hour	<input type="text" value="00:00"/>	Ending hour for the device's daily schedule

- Alert Settings

Disable Alerts	<input type="checkbox"/>	Disable alert notifications for this device
Notify Again Time	<input type="text" value="6"/> <input type="text" value="Hr"/>	Time after which alert notifications will be sent again
Notify on return to normal	<input checked="" type="checkbox"/>	Send a notification when this device returns to normal status
Auto acknowledge	<input checked="" type="checkbox"/>	Automatically acknowledge alert when device returns to normal status
Enable Syslog Alerts	<input type="checkbox"/>	Send alerts for this device via syslog
Enable SNMP Traps	<input type="checkbox"/>	Send alerts for this device via SNMP traps
Enable E-mail Alerts	<input checked="" type="checkbox"/>	Send alerts for this device via e-mail
E-mail Subject	<input type="text" value="E-16D Web Demo IP Alert"/>	Subject of e-mails sent for alerts
Enable SMS Alerts	<input type="checkbox"/>	Send alerts for this device via SMS
Send custom SMS	<input type="checkbox"/>	Replace standard SMS with a customized message
Customized SMS	<input type="text"/>	Customized SMS message sent for alerts
Enable Siren	<input type="checkbox"/>	Turn on the siren when this device goes to alert
Enable Beacon	<input type="checkbox"/>	Turn on the beacon when this device goes to alert
Associated Output Relay	<input type="text" value="None"/>	Name of the output relay that can be controlled by this IP Device
Output Relay status on alert	<input type="text" value="Active"/>	Status of the output relay when going to alert
Output Relay status on return from alert	<input type="text" value="Active"/>	Status of the output relay when returning from alert

+ Data Logging

Alert Simulation

When using SMS messaging, if special characters (other than English) are desired, in order to receive them via SMS, the modem SMS format must be set to PDU (see page 79)

Figure 68- IP Device Configuration-more

61

Group Settings	Description
Group	Assign the device IP to any or all groups 1 -8 (see also page 45)
Schedule Settings	
Schedule Type	Always active- system will react to alert condition at all hours of each day Active during defined times- system will only react to alert condition during times as outlined below
Start Day	First day of the week the system should react to alert condition
End Day	Last day of the week the system should react to alert condition
Start Hour	First hour of the day the system should begin reacting to alert condition
End Hour	Last hour of the day the system should react to alert condition
Alert Settings	
Disable Alerts	Place a checkmark in the box to prevent alerts from being sent when the device's status changes <i>Note: If alerts for an IP device are disabled, the associated output action (see outputs"- page 35) will still take place. There just won't be any alert notifications that this is occurring. For example, this might be used to turn ON a device, such as a fan, when the server room gets too warm, and OFF again when the temperature returns to normal. An alert message may not be desired under these circumstances.</i> <i>Note: if the user wants to disable alerts for an IP device after the device is already in alert status, the user must either acknowledge or dismiss the alert first.</i>
Notify Again Time	Enter the amount of time in seconds, minutes, or hours (1-999) before an alert message will be repeated
Notify on Return to Normal	The user can also be notified when the IP device status has returned to normal by selecting the " Notify when return to normal " box for a device.
Auto Acknowledge	Place a checkmark in this box to have alert notifications in the summary page return to normal state automatically when sensor readings return to normal.
Enable Syslog Alerts	Place a checkmark in this box to have alert notifications sent via Syslog messages
Enable SNMP traps	Place a checkmark in this box to have alert notifications sent via SNMP traps (v2c)
Enable Email Alerts	Place a checkmark in this box to have alert notifications sent via Email
Email Subject	Enter the subject to be viewed when an email alert message is received (up to 60 characters)
Enable SMS Alerts	Place a checkmark in this box to have alert notifications sent via SMS messages (requires a modem) or, see alternative method using User configuration on page 94
Enable Siren	Turn ON the siren when this device goes to alert (not applicable to E-2D)
Enable Beacon	Turn ON the beacon when this device goes to alert (not applicable to E-2D)
Associated Output Relay	Associate the IP Device with the operation of an output relay, or not. By Default, the operation of an output relay can only be associated with one sensor or IP Device. To associate an output relay with more than one sensor or IP Device, place a checkmark in the checkbox under "System- Other Options- Disable Relay Interlock (page 76). <i>Note: Only one sensor/device should be associated with the Output Relay at a time. Contradicting commands from two or more sensors will result in the output relay responding to the state directed by the last command received.</i> <i>Note: If the Output Relay is associated with a sensor/device, and configured to change state when a sensor crosses threshold into alert, it will change state even if the alerts are disabled.</i>
Output Relay Status on Alert	State the output relay will be in when IP Device goes to an alert
Output Relay Status on Return from Alert	State the output relay will be in when IP Device is no longer in alert

Data Logging	
Add to data log	This is a check-box that lets the user decide if the data sampled should be recorded in the Data Log.
Logging Period	Enter the time period between logged measurements

IP Sensors

Sensors connected to an E-MICRO-T(RHP), E-1W or PWR-RMT-RBT-C13 can be monitored and configured from the E-xD interface.

On the IP Sensors page, click on “Add New IP Sensor”. On the page that opens, enter a description to be viewed on the sensor summary page for this group of sensors, enter the IP Address of the E-MICRO, E-1W or PWR-RMT-RBT-C13 to be monitored, and select the Sensor Type between E-MICRO "MICRO" , E-1W "E1W" or the PWR-RMT-RBT-C13. See the chart below for the combinations of these IP Sensors that can be added. When finished, click on “Add”.

Select HTTP or HTTPS for the HTTP Protocol depending on how the web server type is configured in the associated IP Sensor being added.

Note: PWR-RMT-RBT-C13 only supports HTTP Protocol.

Add New IP Sensor

Add New IP Sensor

Description
Descriptive name for the IP Sensor

IP Address
IP Address of the unit

Sensor Type
IP Sensor Type

HTTP Protocol
Select Web Server Type if HTTP or HTTPS as

Figure 69- Add IP Sensor

There is a limit to the total number of IP sensors that can be connected in combination as follows:

	E-MICRO-TRH(P)	E-1W(P)	PWR-RMT-RBT-C13
COMBINATION 1	3	3	2
COMBINATION 2	8	4	0

If a PWR-RMT-RBT-C13 is connected as an IP sensor (up to 2), then up to 3 each of the E-MICRO-TRH(P) and/or E-1W(P) can also be connected.

If no PWR-RMT-RBT-C13 is connected as an IP sensor, then up to 8 E-MICRO-TRH(P) and/or up to 4 E-1W(P) can be connected as IP sensors.

The E-xD will then sense what sensors are attached to the E-MICRO, E-1W and PWR-RMT-RBT-C13 units and add them to your summary list under “IP Sensors”. Once listed, to view the status of an individual sensor, click on “View”. To change the configuration, click on “Edit”.

IP Sensors

IP Sensors					
No.	Description	Type	Value	Status	Action
1	E-MICRO P06			Responding	Edit Delete
I.1	Integrated Temperature	Temperature	23.6°C	Normal	View Edit
I.2	Integrated Humidity	Humidity	24%	Normal	View Edit
I.3	Integrated Dew Point	Dew Point	1.9°C	Alarm	View Edit
D.1	Digital Input #1	Digital Input	Open	Normal	View Edit
D.2	Digital Input #2	Digital Input	Open	Normal	View Edit

[Add New IP Sensor](#)

Figure 70- IP Sensor List

In a [cascaded configuration](#) of E-xD units, IP sensors (maximum of 16) must be configured from the Master unit to receive alerts about those sensors.

Configuration settings for IP Sensors are the same as those described under External Sensors on page 43 with one exception, the Min. Level and Max. Level are user-adjustable for Temperature and Dew Point sensors. If the default range of these sensors is too large or small, you can change the displayed values by entering the temperature range you want displayed. This change will effect the colored graphic status bar range displayed.

If the IP Sensor is a Digital Input or Output Relay, the configuration settings described on pages 55 and 58 will be used.

To restore the range to default values for the sensor, you can delete the sensor from the summary page and when the ENVIROMUX re-discovers the sensor it will restore it to the default sensor range.

Note: *The configuration settings applied to these sensors in this interface will not alter the settings as configured within the E-MICRO or E-1W web interface.*

Temperature #4 Configuration (Type: Temperature)

☰ **Sensor Settings**

Description	<input type="text" value="Temperature #4"/>	<small>Descriptive name for the sensor</small>
Name in LED Display	<input type="checkbox"/> <input style="width: 100px;" type="text"/>	<small>Optional short name of the sensor as viewed in the LED Display(14 characters limit)</small>
Units	<input type="text" value="Deg. C"/> <input type="button" value="v"/>	<small>Select the units for the sensor</small>
Min. Level	<input type="text" value="-40.0"/>	<small>Min. supported value for the sensor</small>
Max. Level	<input type="text" value="85.0"/>	<small>Max. supported value for the sensor</small>
Min. Non-Critical Threshold	<input type="text" value="15.0"/>	<small>Min. threshold below which indicates a non-critical alert condition</small>
Max. Non-Critical Threshold	<input type="text" value="45.0"/>	<small>Max. threshold above which indicates a non-critical alert condition</small>
Min. Critical Threshold	<input type="text" value="10.0"/>	<small>Min. threshold below which indicates an alert condition</small>
Max. Critical Threshold	<input type="text" value="50.0"/>	<small>Max. threshold above which indicates an alert condition</small>
Refresh Rate	<input type="text" value="10"/> <input type="button" value="Sec"/> <input type="button" value="v"/>	<small>The refresh rate at which the sensor view is updated</small>
Enable Graph	<input type="checkbox"/>	<small>Enable graph for this sensor</small>
Sensor Offset	<input type="text" value="0.0"/>	<small>Value offset to correct ambient heating</small>

For IP Sensors, Temperature and Dewpoint Minimum and Maximum Level can be changed to improve the displayed values in the web interface.

Figure 71- IP Sensor Settings for Temperature and Dewpoint

Status of AC Output and Digital Outputs can be changed as per Triggers set in PWR-RMT-RBT-C13 OR based on Events/Sensors set in E-xD, but not both. If both are set to edit the status of PWR-RMT-RBT-C13 Outputs, they may conflict with each other. So if you change the state of a Digital Output/AC Output on the PWR-RMT-RBT-C13 from within the E-xD interface using Events of E-xD, you will also change the Digital Output/AC Output to "Manual" Trigger Type, regardless if it was configured as "Auto" Trigger Type within the PWR-RMT-RBT-C13 interface. This Output will no longer use its Trigger Sources until you change it back to "Auto" Trigger Type by logging into PWR-RMT-RBT-C13 directly (see Figure 72).

4	PWR-RMT-RBT-C13 E03			Responding	Edit Delete
D.1	Digital Input #1	Digital Input	Open	Normal	View Edit
D.2	Digital Input #2	Digital Input	Open	Normal	View Edit
I.1	IP Device #1	IP Device	Responding	Normal	View Edit
I.2	IP Device #2	IP Device	Responding	Normal	View Edit
A.1	Analog Output #1	AC Output	Active	Normal	Turn Inactive Cycle Edit
O.1	Digital Output #1	Digital Outputs	Inactive	Normal	Turn Active Edit
O.2	Digital Output #2	Digital Outputs	Inactive	Normal	Turn Active Edit

Changing the Output's state from Inactive to Active (or vice versa) will change its mode from Trigger Mode to Manual mode.

Figure 72- PWR-RMT-RBT-C13 Sensors List

SNMP Sensors

The ENVIROMUX is able to poll and report the status of conditions from up to 32 third-party SNMP devices (requires firmware version 2.61 and later). The Summary page provides a link to view the status of SNMP monitored conditions of network-connected devices and using [Smart Alerts or Events](#) the user can be notified when conditions are outside of desired parameters.

Note: No alerts can be set directly on an SNMP sensor itself. Therefore, the Status will always be reported as "Normal" on the summary page while polling.

Below the E-xD is monitoring another ENVIROMUX for the amount of available free memory and the CPU Idle time based on percentage (i.e. this E-16D is idle 17% of the time meaning the processor is busy working 83% of the time). We further have a sensor configured polling for the state of an IPDU Output relay (power socket). "1" indicates ON, "0" would indicate OFF.

SNMP Sensors					
No.	Description	Type	Value	Status	Action
1	E-16D-24V IPMI Rack Memory Free	SNMP Sensor	17264	Normal	View Edit Delete
2	IPDU Output Relay 1	SNMP Sensor	1	Normal	View Edit Delete

Figure 73- SNMP Sensor status on Summary Page

To add an SNMP Sensor, go to the SNMP Sensors Page under Monitoring. Click on "Add New SNMP Sensor".

SNMP Sensors

SNMP Sensors					
No.	Description	Type	Value	Status	Action
1	E-16D-24V IPMI Rack Memory Free	SNMP Sensor	17280	Normal	View Edit Delete
2	IPDU Output Relay 1	SNMP Sensor	1	Normal	View Edit Delete

[Add New SNMP Sensor](#)

Potential "Value" Error Messages:
 "Not Responding" = Device is OFF or Check the IP address
 "Invalid OID" = Verify correct OID
 "Invalid Type" = Value type mismatch
 "Error" = Check settings (IP, OID, Value type etc.)

Figure 74- SNMP Sensor page

Enter the information required for the new sensor. (See image next page.)

SNMP Sensor Settings	Description
Description	Descriptive name to be displayed on the Summary Page for the SNMP Sensor
IP Address	IP Address of the SNMP Device that will be polled
OID	Object Identifier of the SNMP Device characteristic to be reported in the format of numbers separated by a period (see also How to setup SNMP)
SNMP Version	SNMP Version to be used to poll this SNMP sensor- v1/2c/3
SNMP Value Type	Select INTEGER, STRING to FLOAT, INTEGER to FLOAT or STRING If SNMP Device value type is "Counter32","Timetick", "Gauge32" or "Integer"- select INTEGER If SNMP Device value type is "Octet String" with float format- select STRING to FLOAT If SNMP Device value type is "Octet String"- select STRING If SNMP Device value type is "Integer" but was float format originally- select INTEGER to FLOAT. Also select appropriate optional Divisor to convert value to FLOAT
Username	When SNMPv3 is selected, the username that must be presented to poll the device
Authentication Protocol	Select None, MD5 or SHA
Authentication Passphrase	The passphrase assigned to be used to enable the receipt of SNMP v3 messages
Privacy Protocol	Choose between DES or AES (v128) if SNMP readings or traps are encrypted or "None" if they are not. If encryption is enabled, then the Authentication Protocol must also be set at "MD5" or "SHA".
Read-only community name	Enter applicable name (commonly used- "public")

Data Logging	
Add to data log	This is a check-box that lets the user decide if the data sampled should be recorded in the Data Log.
Logging Period	Enter the time period between logged measurements

SNMP Sensor Configuration

SNMP Sensor Settings

Description	<input type="text" value="E-16D-24V IPMI Rack M"/> Descriptive name for the SNMP Sensor
IP Address	<input type="text" value="192.168.1.100"/> IP Address of the SNMP Device
OID	<input type="text" value=".1.3.6.1.4.1.2021.4.11.0"/> OID of the SNMP Device
SNMP Version	SNMPv2c <input type="button" value="v"/> Select the SNMP version to be used for this sensor
SNMP Value Type	INTEGER <input type="button" value="v"/> Select the SNMP value type
Username	<input type="text"/> Username setup on the SNMPv3 device
Authentication Protocol	None <input type="button" value="v"/> Select the authentication protocol for this SNMPv3 user
Authentication Passphrase	<input type="text"/> The authentication passphrase for this SNMPv3 user
Privacy Protocol	None <input type="button" value="v"/> Select the privacy protocol for this SNMPv3 user
Privacy Passphrase	<input type="text"/> The privacy passphrase for this SNMPv3 user
Read-only community name	<input type="text" value="public"/> Read community string for the SNMPv1/v2 device

Data Logging

Add to data log	<input type="checkbox"/> Add readings to the data log
Logging Period	<input type="text" value="60"/> <input type="button" value="Min"/> <input type="button" value="v"/> Frequency at which readings are added to the data log.

Figure 75- SNMP Sensor Configuration page

Once the Sensor is setup to be polled, alerts can be configured using the Smart Alert- Event settings. Click on "Create New Event".

Events

No.	Event Description	Sensor	Trigger Val.	Current Val.	Status	Action
1	Event #3 IPDU Output Relay 1	IPDU Output Relay 1	< 1.0	1	Normal	Ack Dismiss Delete
2	Event #4 E-16D-24V IPMI Rack Memory Free	E-16D-24V IPMI Rack Memory Free	< 16500.0	17280	Normal	Ack Dismiss Delete

[Create New Event](#)

Figure 76- Events page under Smart Alerts

In the example (right), the Event configuration is setup to send an alert when the threshold (free memory) drops below 16500 bytes.

All of the usual notification methods are available to have alerts sent to any configured users.

Visual notification in the Web Interface of an alert will also be seen on the Events page and under Events on the Alarm Information page.

Event #3 E-16D-24V IPMI Rack Memory Free Configuration

Event Settings

Description Event #3 E-16D-24V IPM
Descriptive name for the event

Threshold 16500.0
Threshold which indicates an alert condition

Threshold Type Less Than
Select the threshold type

Event Delay 1 Sec
Duration the sensor must be out of thresholds before the event is triggered

When triggered, acknowledge the following event None

Group Settings

Event Notifications

Notify Again Time 30 Hr
Time after which alert notifications will be sent again

Notify on return to normal Send a notification when this sensor returns to normal status

Auto acknowledge Automatically acknowledge alert when sensor returns to normal status

Enable Syslog Alerts Send alerts for this event via syslog

Enable SNMP Traps Send alerts for this event via SNMP traps

Enable E-mail Alerts Send alerts for this event via e-mail

E-mail Subject E-16D-24V IPMI Rack Memory Free Low
Subject of e-mails sent for alerts

Select IP Camera Wanscam HW0041-1
Select IP camera for image capture on alert

Attach IP camera capture to e-mail Attach captured image from selected IP camera to alert e-mail

Save image to USB Save captured image from selected IP camera to USB Flash

Enable SMS Alerts Send alerts for this event via SMS

Remote SSH Commands

Figure 77- Event settings for SNMP Sensor being monitored

IP Cameras

The IP Camera page displays the video snapshots of up to 8 monitored IP cameras. ENVIROMUX will display the video from specified IP addresses and provide images at 320 x 240 resolution. Place a name, the URL or IP address of the link, and the name of the image taken by the camera in the blocks provided (examples below). The images can be set to be refreshed every 100 msec (.1 second) up to 99,900 msec (almost 100 seconds).

Click **Save** at the bottom of the page. Then click on **Monitoring->IP Cameras** to see the images taken by those cameras. The user can click on any image and be connected to the site defined by the configuration.

If your camera requires authentication in order to view images or send images via email, place a checkmark in “**Enable HTTP Auth**” and add the **Username** and **Password** that your camera has been configured to accept. For more on viewing cameras requiring authentication, see page 71.

IP Cameras

Bench Camera



Engineering Camera

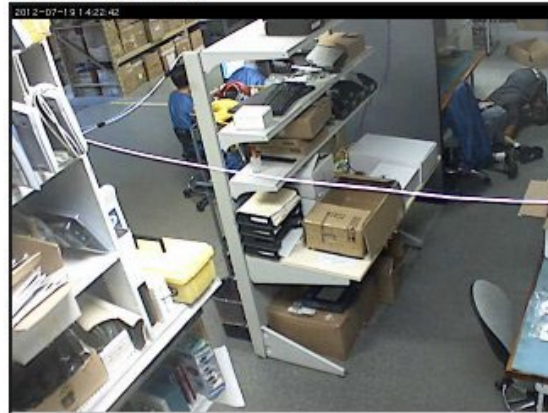

Server Camera



NTI Front Entrance



[Configure IP Cameras](#)

Figure 78- Monitoring IP Cameras

Configure IP Cameras

IP Camera #1	
Add to View	<input checked="" type="checkbox"/> Enable this camera in the View page
Name	<input type="text" value="FDT FD9902W"/> Name of the IP camera
Image URL	<input type="text" value="192.168.3.7/cgi-bin/hi3510/wr"/> Full path of the image file of the IP camera
URL Type	<input type="text" value="JPEG"/> Select IP Camera URL resource type. For RTSP URL's, management software is needed
IP Address	<input type="text" value="192.168.3.7"/> IP address of the IP camera
Refresh Rate (x100 msec)	<input type="text" value="1"/> Refresh rate of the image in hundreds of milliseconds
Enable HTTP Auth	<input checked="" type="checkbox"/> Use HTTP Authorization to access this camera
Enable Digest Access	<input type="checkbox"/> Use Digest Access Authentication to access this camera
HTTP Auth Username	<input type="text" value="admin"/> Username to be used in HTTP Authorization
HTTP Auth Password	<input type="password" value="AAAAA"/> Password to be used in HTTP Authorization
IP Camera #2	
IP Camera #3	
IP Camera #4	
IP Camera #5	
IP Camera #6	
IP Camera #7	
IP Camera #8	
<input type="button" value="Save"/>	

Once this is configured, test to see if images come via email. (See below)
 If not, your camera may require "Digest Access Authentication" to work. In this case, place a checkmark in "Enable Digest Access".

Caution: Don't enable this unless it is necessary, because if it isn't needed, you won't get emails from cameras that don't support this feature.

Figure 79- IP Camera Configuration

The images from web cameras can also be associated with alert messages. When configured (page 46), an image from an IP camera can be taken and sent along with a sensor alert message via email and/or saved to a connected USB flashdrive.

Note: If your camera's security can be disabled, and you don't want to use it to be able to send IP camera captures as e-mail attachments, then disable it. The "Enable HTTP Auth" and "Enable digest Access" features are provided for cameras the require authentication to view images or send images via email. Consult your IP camera manual to see if this feature is present and for instructions on how to configure this.

For available cameras compatible with the E-xD, visit our website at <http://www.networktechinc.com/ip-camera.html>

For cameras that require authentication to view images, when you initially view this page in your web browser the image will have a placeholder instead.

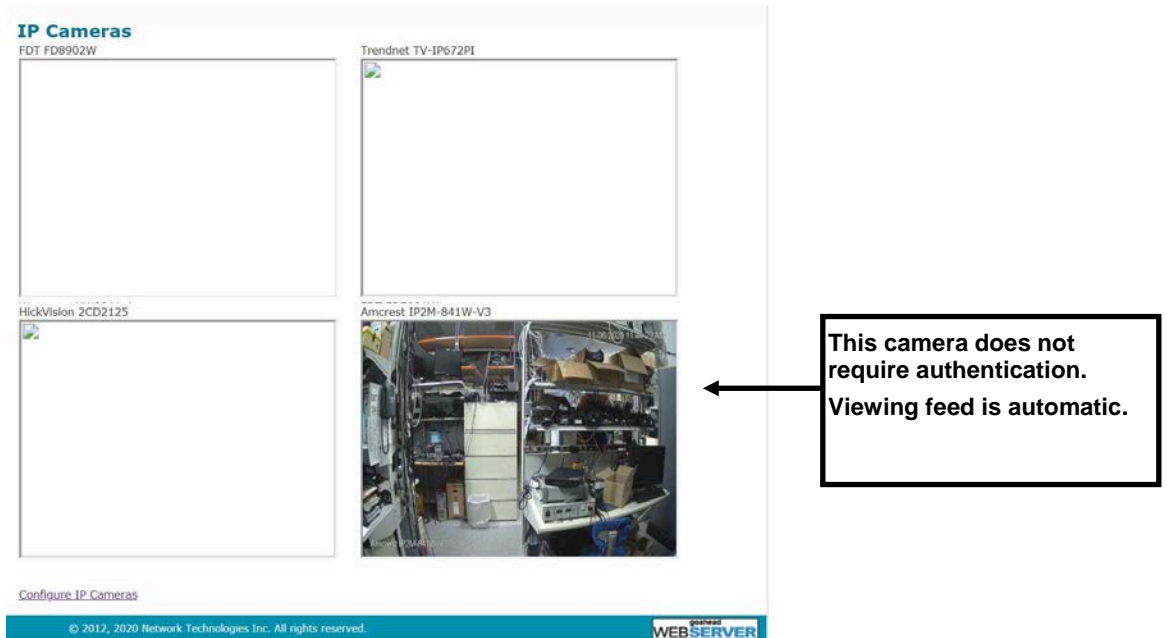
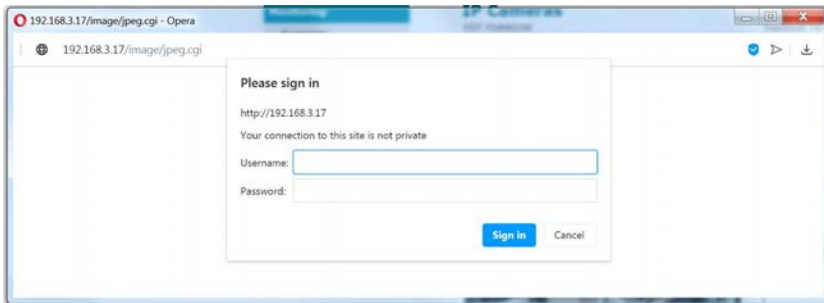

Figure 80- Cameras requiring authentication



If you click on the block where the image should be, you will be asked to login to the camera with the username and password required to access the camera.

Figure 81- Camera access login

After signing in to the camera, the image will be shown in the ENVIROMUX web interface as long as you have that web browser open.

Note: If you close the browser, you will have to sign in again to view the camera feed.

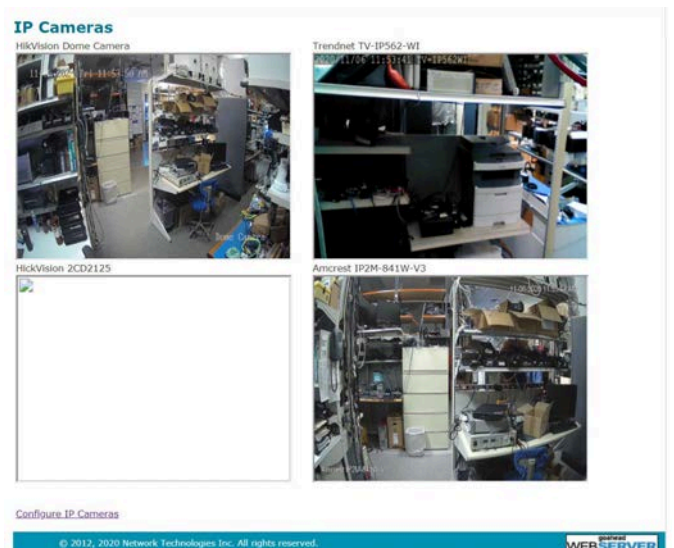

Figure 82- Camera feed after login

Administration

From the Administration section there are several sub sections for configuring the ENVIROMUX:

Administration		
System	System	Fields for applying time zone, date, time, NTP server, backup and restore configuration settings and settings for the "RS232 AUX" port
Enterprise	Enterprise	Fields for assigning the unit name, address, contact person, the ENVIROMUX e-mail address, and phone number of a contact person
Network	Network	Fields for providing all the network settings the ENVIROMUX including IP address, DNS, SMTP, SNMP and MQTT settings
Users	Users	Fields for assigning users, access privileges, passwords, contact settings, and schedule settings
Maps Config	Maps Config	Setup maps for entering locations of sensors
Groups	Groups	Fields for assigning names to the groups that will receive alerts and messages
Security	Security	Fields for setting authentication method and IP Filtering
System Information	System Information	For viewing ENVIROMUX system information
Firmware	Firmware	For updating the firmware of the ENVIROMUX when improved software becomes available.
Cascading	Cascading	For controlling up to 4 ENVIROMUX slaves from one master unit
Reboot	Reboot	Enables user to reboot the ENVIROMUX using the web interface

System Configuration

The System Configuration section is where all the settings necessary for proper time reporting within alert messages and log records are configured. To view the System Configuration page, click on **System** from the **Administration** section of the menu.

The screenshot shows the 'System Configuration' page with the following sections and settings:

- Time Settings:**
 - Time zone: (GMT-05:00) Eastern Time (US & Canada)
 - Enable Daylight Saving: Automatically adjust clock for daylight saving changes
 - Set Date: MM-DD-YYYY
 - Set Time: AM
 - Enable NTP: Get system time via Network Time Protocol
 - NTP server: 0.nti.pool.ntp.org
 - NTP Frequency: 60
 - E-mail Time Stamp: Add time stamp to e-mail alerts
 - SMS Time Stamp: Add time stamp to SMS alerts
 - Holiday Dates: (Empty text area)
- Configuration Backup & Restore**
- Language**
- Auxiliary Serial Port Configuration**
- RSA Public Key**
- Alert E-mail Format**
- Sensor Settings**
- Save** button

Figure 83- System Configuration page

The Date and Time of the ENVIROMUX can be either manually setup to use an onboard clock or set to be synchronized with an NTP server. The configuration of the ENVIROMUX can also be easily backed up to a file on your PC and restored from that file as needed. Once setup, they are stored with the help of a replaceable date/time battery. For instruction on how to replace that battery, see the [ENVIROMUX Battery Replacement](#) instructions.

Time Settings	Description
Time Zone	Enter the appropriate time zone (select from the dropdown list)
Enable Daylight Saving	Apply a checkmark to have the time change according to Daylight Saving Time rules
Set Date	Enter the system date in MM-DD-YYYY, DD-MM-YYYY or YYYY-MM-DD format
Set Time	Enter the system time of day in hh:mm:ss format and select AM, PM or 24 HOUR
Enable NTP	Place a checkmark to enable the ENVIROMUX to automatically sync up with a time server via NTP
NTP server	If the NTP is enabled, enter the Domain Name or IP address of the NTP server
NTP Frequency	Enter the frequency (in minutes) for the ENVIROMUX to query the NTP server (minimum is 5 minutes)
E-mail Time Stamp	Place a checkmark to have the ENVIROMUX apply a time of day stamp in the alert message sent via email
SMS Time Stamp	Place a checkmark to have the ENVIROMUX apply a time of day stamp in the alert message sent via SMS
Holiday Dates	Enter dates that you want the alert message schedule (page 47) to be altered
Configuration Backup & Restore	
Choose file	<p>Browse for a saved configuration file to be restored to the ENVIROMUX. Upon selection, press “Save” and the ENVIROMUX will restore the configuration settings and reboot. Allow 1 minute before trying to reconnect and log in again.</p> <p>Note: The IP address will be set to the IP address in the file and may be different</p> <p>Note: Before overwriting the existing configuration, consider whether the existing configuration should be saved first. If it will be saved, be sure to save the current configuration file under a different name than the configuration file to be loaded.</p>
Download Configuration File	Click this button to save the configuration of the ENVIROMUX to a location on your PC. This file can be restored using the “Choose file” field in the event you wish to return the ENVIROMUX to a former state
Restore Defaults	Click this button to restore the ENVIROMUX to the configuration settings it had upon receipt from the factory. Be careful! This will erase <u>all</u> user configuration settings. Upon restoration, the ENVIROMUX will reboot. Allow 1 minute before trying to reconnect and log in again. Confirmation is required.
Language Selection	
Select Language	Select between English, German (Deutsch) and Japanese for the language to read the ENVIROMUX menus in.

Note: If “Restore Defaults” is used, the IP address will also be restored to its default address (192.168.1.21) with a login name “root” and password “nti”. To restore the root password to “nti” without having to restore all default settings, please send a backup of your config file, that you had taken previously, to NTI.

To identify the IP address of the ENVIROMUX without restoring defaults, use the Discovery Tool (page 28).

Downloading the configuration file is particularly useful when preparing to make changes to the configuration that may provide unsatisfactory results. If the configuration is saved in a file before changes are made, stepping backward and restoring the previous settings is as simple as clicking on the file saved. Just be sure to remember the name of the file saved and where in the PC it was saved.

Default settings can also be restored using the “Restore Defaults” button on the front of the ENVIROMUX (see page 121).

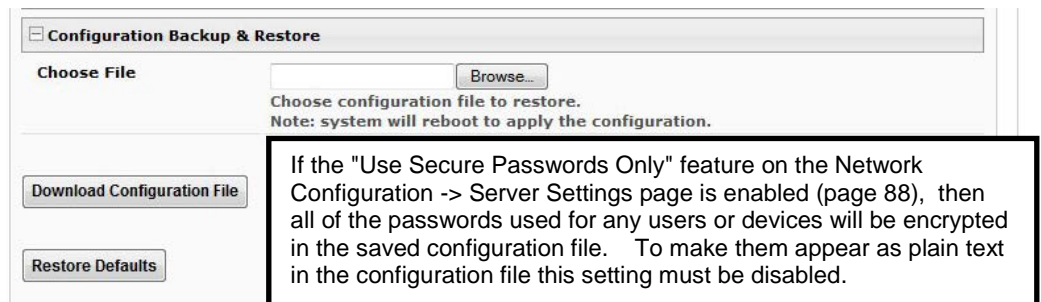

Figure 84- Configuration Backup and Restore

The configuration file is in JSON format and can be edited using any text editor (Microsoft Word, Wordpad, Notepad, etc.).

NOTE: The format and syntax of the settings should not be changed when editing this file or the device may become unusable. Save a copy of the file as backup before making edits, in case a mistake is made. It can then be reinstated after resetting the ENVIROMUX to defaults using the "Restore Defaults" button on the front.

Auxiliary Serial Port Configuration ("RS232 AUX")	
Use Aux Port for	Choose between Remote Serial Port or Console <ul style="list-style-type: none"> ➤ Configure as a Remote Serial Port when the port will be used to control a remote serial device. ➤ Configure as a Console port when a terminal will be connected for serial control of the ENVIROMUX (E-5D only) <p>Note: Serial GSM Modem feature is no longer supported</p>
Baud Rate	When "Remote Serial Port" is selected, set the Baud Rate to a speed compatible with the connected serial device. Speeds range from 1200bps through 115200bps. When Console is selected, set to a speed compatible with the connected terminal
Format	When "Remote Serial Port" is selected, enter the number of bits, parity, and number of stop bits for the remote serial device to be connected. When Console is selected, enter the number of bits, parity, and number of stop bits for the terminal to be connected (usually 8-N-1)

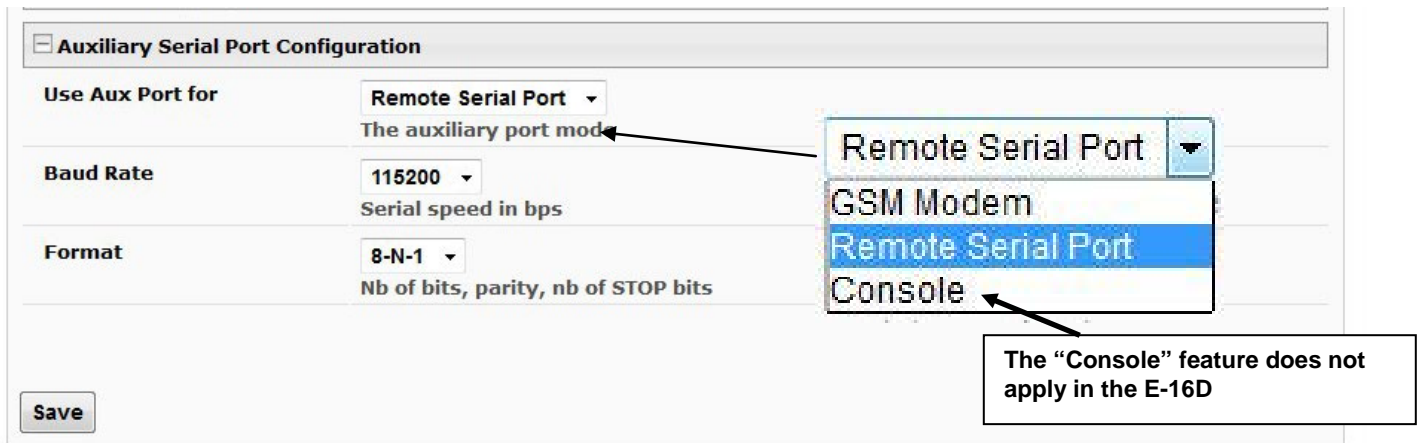

Figure 85- Configure the purpose of the "RS232 AUX" port

RSA Public Key

Alert E-mail Format

Hide Enterprise Field	<input type="checkbox"/>	Do not show Enterprise field in the body of alert e-mails
Hide Location Field	<input type="checkbox"/>	Do not show Location field in the body of alert e-mails
Hide Branch Field	<input type="checkbox"/>	Do not show Branch field in the body of alert e-mails
Hide Rack Field	<input type="checkbox"/>	Do not show Rack field in the body of alert e-mails
Hide Group Field	<input type="checkbox"/>	Do not show Group field in the body of alert e-mails
Hide Contact Field	<input type="checkbox"/>	Do not show Contact field in the body of alert e-mails

Figure 86- System Configuration-continued

RSA Public Key

Click on this button to save an authentication key to a Linux or Unix machine. In order to configure an Event or Smart Alert to cause an SSH command to be sent to a Linux or Unix machine automatically (see [How to setup Smart Alerts](#)), the Linux or Unix computer must be configured to accept the command from the ENVIROMUX. To do this, save the RSA public key, filename `id_rsa.pub`, to the computer(s) to receive remote SSH commands.

Then, on the computer to execute the command, log in as the user and execute the below command from the directory where the file was downloaded:

```
$ cat id_rsa.pub >> <user_home_directory>/.ssh/authorized_keys
```

This command will append the ENVIROMUX key to the list of authorized keys

Then, to make the change take effect, restart the SSH server by typing:

```
$ sudo service ssh restart
```

Alert E-mail Format

To customize the content of the alert messages received via e-mail, pieces of information that would normally be contained in the emails can be omitted. For each piece of information that you do not want to be shown, place a checkmark in the category. Once you click on "Save", your changes will be made in the ENVIROMUX.

Sensor Settings	
Disable Sensor Graphs	<input type="checkbox"/> Disable graphs on sensor status page for external sensors
Disable Relay Interlock	<input type="checkbox"/> Check the box to allow relays to be controlled by multiple alerts
DI Poll Frequency	800 ms <input type="button" value="v"/> Select frequency in ms at which digital input is sampled(Recommended: 800 ms) Note: system needs a restart for settings to take effect.
Siren/Beacon Timeout	0 in Seconds. Siren/Beacon will auto silence after specified period until Notify Again time. Set to 0 to disable timeout and keep it on.
<input type="button" value="Save"/>	

Figure 87- Sensor Settings

Sensor Settings

Disable Sensor Graphs - When checking the status of external RS485 sensors, by default a graph is displayed with the accumulative readings for that sensor (see page 39). The display of that information will take some additional time for your browser to provide. If you don't wish to have that graph displayed and would rather speed up the status information of these sensors, you can place a checkmark in "Disable Sensor Graphs".

Disable Relay Interlock - This checkbox that allows you to enable or disable the ability to have output relays controlled by multiple alert conditions. By default this box is unchecked.

While unchecked, each output relay can only be associated with one alert.

When this box is checked, the same output relay can be associated with multiple alert conditions and will have its state (open or closed) changed according to the configuration with each association (see page 45).

DI Poll Frequency - Select how often digital inputs will be read. Selections include every 200 through 800 milliseconds, with 800 being the default.

Siren/Beacon Timeout- Enter the number of seconds to elapse before the Siren or Beacon will auto silence until the Notify Again time has elapsed. Set to 0 seconds to disable the timeout and keep the Siren or Beacon ON.

Click on **Save** when finished with System Configuration.

Administration-Enterprise Setup

The Enterprise Setup page (**Administration ->Enterprise**) is used to enter basic company information to be applied to the body of alerts. Enter the information to the blocks provided with your company name, location, the contact person that alert e-mails should refer to, the phone number to reach them, and the e-mail address assigned to the E-16D.

If SMS messages will be used as an alert method, a GSM modem will be needed and this page will provide status information for that connection as well as the ability to configure alerts to be sent if the modem connection fails (see also page 18).

Note: *If the e-mail address you supply doesn't work, one possible cause may be the policy of the server. Verify that the introduced Enterprise e-mail address will be accepted by the server. With some SMTP servers, messages may be rejected prompting an error message to be logged and alert messages being blocked from reaching their destinations.*

Note: *Enterprise name is also used as FQDN. [See page 84 for more details.](#)*

To personalize a banner that will be displayed on the login page, place a checkmark in the "Login Banner" box and enter up to 1500 characters to be displayed at login.

Enterprise Configuration

<input type="checkbox"/> Enterprise Settings	
Enterprise Name	E-16D 48V Name to identify this unit
Location	NTI Location/Address
Branch	Engineering Branch
Rack	B17C Rack
Contact	Engineering Contact person
Phone	330-562-7070 Phone number of contact person
E-mail	user@gmail.com E-mail address for messages sent from this unit
Login Banner	<input checked="" type="checkbox"/> Display login banner
Banner Message	<div style="border: 1px solid #ccc; height: 150px; width: 100%;"></div> Enter the login banner message (1500 characters max)
<input type="checkbox"/> GSM Modem Status	
<input type="checkbox"/> GSM Modem Error Alerts	
<input type="checkbox"/> SMS Relay	
<input type="button" value="Save"/>	

Figure 88- Enterprise Configuration Page

GSM Modem Status

If a modem has not yet been connected, the message "Not Available" will appear on the setup menu. The modem must be powered ON and connected before the ENVIROMUX is powered ON.

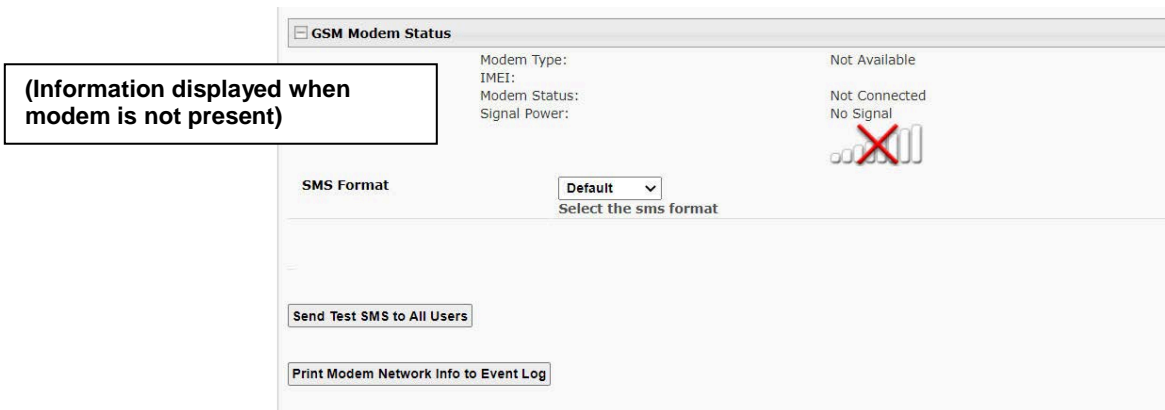

The connected modem must have a GSM type SIM card configured for SMS messaging and should be "unlocked" to prevent it from being limited to use in just this modem without further configuration.

When a modem is present, the type, status, IMEI number, and signal strength will be displayed. The modem will work with a signal strength between -111dBm (weak) and -51dBm (strong).



Figure 89- GSM Modem Status

GSM Modem Error Alerts

If the modem fails to send an SMS when prompted to do so due to loss of service provider connection, error in protocol, or if the connection runs out of prepaid minutes, the ENVIROMUX can be configured to send an alert message via Email, Syslog and/or SNMP. Select what group(s) this notification will belong to and what methods of communication to use and click "Save".

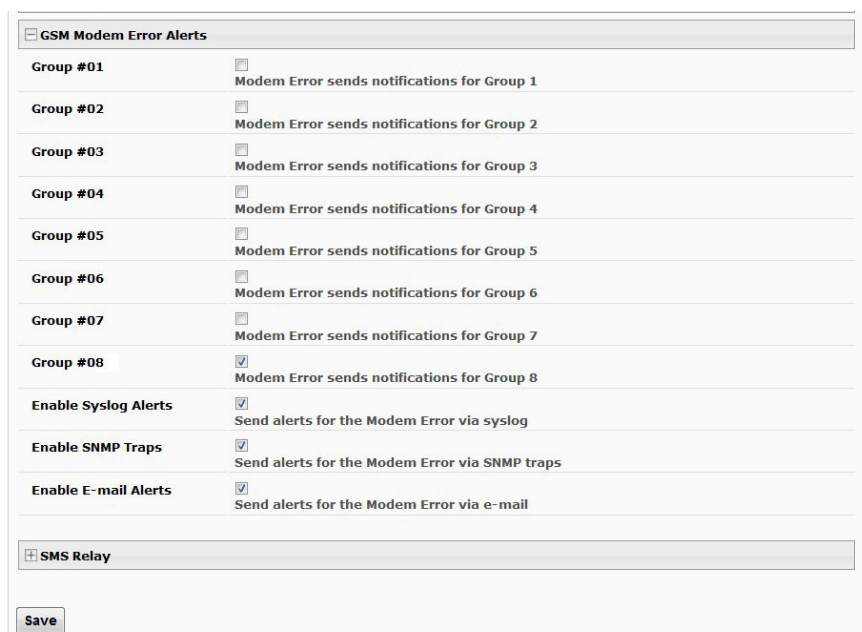
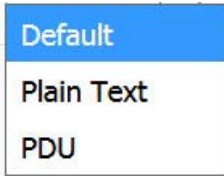

Figure 90- GSM Modem Error Alert Configuration

SMS Message Format

In the same screen as the GSM Modem Status is the selection for the SMS message format. Three settings are available for this format:



Default: With this setting, if your language setting is English, the SMS messages will be sent in Plain Text. If the language setting is other than English, the SMS messages will be sent in PDU (Protocol Description Unit) format. This is a format supported by carriers that support extended character sets other than English.

Plain Text: With this setting, regardless of what the language setting is, SMS messages will be sent in a plain text format.

PDU: With this setting, regardless of what the language setting is, SMS messages will be sent in PDU format.

3G and 4G SMS message capabilities are supported, provided the modem supports them.

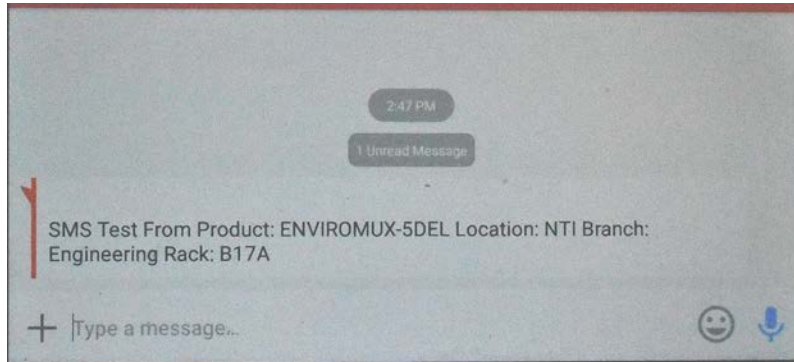

Figure 91- Example of Plain Text SMS Test Message

To test the modem function, click on "**Send Test SMS to All Users**" to send a test message to everyone that has been setup to receive SMS messages from the ENVIROMUX.

Note: A user can also be configured to receive SMS alert messages by entering their carrier's texting address for their email address. (See page 94)

Print Modem Network Info to Event Log

Press the "Print Modem Network Info to Event Log" button if you want to have the ENVIROMUX log the USB modem communication status. This can be used to understand the status of connection with the network carrier, features offered by your carrier, and debugging on communication/SMS failure.

Note: this logging will only work if a valid USB modem is connected with a valid SIM card and that USB modem has been communicating with a carrier.

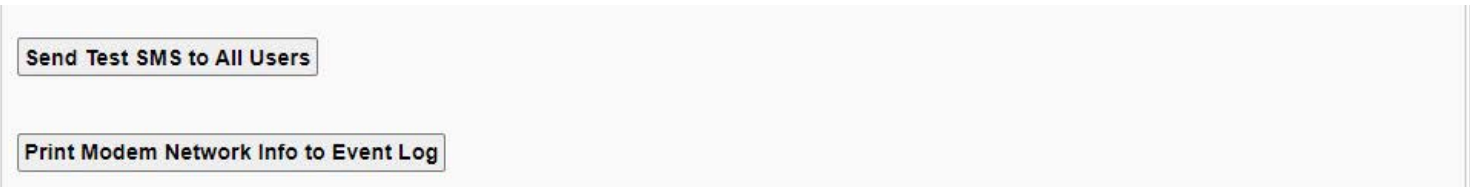

Figure 92- Button for Printing Modem status to the Event Log

Enable SMS Relay

If your network includes more than one ENVIROMUX (E-16D, E-5D and/or E-2D), only one GSM modem is required for all the ENVIROMUX units to send SMS messages. That GSM modem can be connected to any of the ENVIROMUX units. Using the SMS Relay feature, all ENVIROMUX units can send SMS messages through the single GSM modem.

To use the SMS Relay feature;

- If the GSM modem is connected to the ENVIROMUX you are configuring, place a checkmark in “Enable Server” block.
- If the GSM modem is connected to another ENVIROMUX unit, leave “Enable Server” unchecked and instead place a checkmark in “Use remote unit to send SMS” and enter the IP address of the ENVIROMUX unit that has the GSM modem connected to it in the block “Remote unit IP Address”.

Note: SMS Relay feature uses port 6001 on device set as SMS Relay Server (one with USB modem) and uses port 6002 on device set as SMS relay client. If you do not wish to use SMS Relay feature, leave “Enable Server” option unchecked.

Be sure to click “Save” to save the configuration.

Figure 93- SMS Relay Configuration

Note: To use the SMS relay feature between two ENVIROMUXs on a network separated by a firewall, be sure to open ports 6001 and 6002 in the firewall configuration to enable SMS communication between the ENVIROMUXs

If your network has only one ENVIROMUX connected to it, the SMS Relay feature will have no effect

Administration-Network Setup

From the Network Configuration page (**Administration->Network**) the administrator can either choose to have the IP address and DNS information filled in automatically by the DHCP server (the default setting), or manually fill in the fields (use a static address). Settings can be entered for either the IPv4 or IPv6 protocols.

Note: If you select "DHCP", make sure a DHCP server is running on the network the E-16D is connected to.

Network Configuration

The screenshot shows the 'Network Configuration' page with the following settings:

- IPv4 Settings:**
 - IPv4 Mode: Static
 - IPv4 Address: 192.168.3.81
 - IPv4 Subnet Mask: 255.255.255.0
 - IPv4 Default Gateway: 192.168.3.3
 - Preferred DNS: 192.168.1.52
 - Alternate DNS: 166.102.165.11
 - DNS Timeout: 1
- IPv6 Settings:** (Collapsed)
- VLAN Settings:** (Collapsed)
- DDNS Settings:** (Collapsed)
- SMTP Settings:** (Collapsed)
- SNMP Settings:** (Collapsed)
- MQTT Settings:** (Collapsed)
- Server Settings:** (Collapsed)
- 3G/4G Data Connection:** (Collapsed)
- Disable Legacy Management Software:** (Collapsed)

A callout box points to the 'DNS Timeout' field with the text: "If the DNS server is slow to respond, increase this value to up to 30 seconds".

Figure 94- Network Configuration Page

The screenshot shows the 'IPv6 Settings' section with the following settings:

- IPv6 Mode:** Disabled
- IPv6 Address:** (Empty field)
- IPv6 Default Gateway:** (Empty field)
- Enable 6to4 tunnel:** Disabled
- Local IPv4 Address:** (Empty field)
- Remote IPv4 Address:** (Empty field)

Figure 95- Apply IPv4 or IPv6 Settings

If the administrator chooses to have the DNS information filled in automatically, the SMTP server and port number still need to be entered for e-mail alerts to work (see next page). If the SMTP server requires a password in order for users to send e-mails, the network administrator must first assign a user name and password to the ENVIROMUX. Then apply the user name and password to the "User" and "Password" fields under "SMTP Settings". Once all users are configured, click the **"Send Test Email to all Users"** button to check that all settings have been done properly. This will send an email to all users configured in the user list.

For additional detailed information on setting up email, see "[How to Setup Email](#)".

Network Configuration

+ IPv4 Settings

+ IPv6 Settings

- VLAN Settings

Enable 802.1Q VLAN Disabled v

NOTE: This will cause device to drop out of regular LAN. In case device is inaccessible, You can disable VLAN from Serial Console or do system reset

VLAN ID

Set VLAN ID for Tagged Packets

+ DDNS Settings

- SMTP Settings

SMTP Server Type Custom v
Select SMTP server to use for emails

SMTP Server
SMTP server used when sending e-mails

Port
SMTP server port. Usual Port #- No Encryption: 25, TLS: 465, STARTTLS: 587

Email Format HTML v
Email format

SMTP Encryption STARTTLS v
Select the type of SMTP Encryption to use in email

Use Authentication
SMTP server requires authentication to send email

Username
Username for email authorization. For full email address. You may also have Enterprise Settings

Password
Password for sending e-mails

Send Test Email

- SNMP Settings

Enable SNMP Agent SNMPv1/v2c/v3 v
Allow access to SNMP agent on this device

SNMP Port
Port for SNMP requests. Usual Port #: 161

Enable SNMP Traps
Enable sending of SNMP traps from this device

Read-write community name
Read-write community name for SNMP agent

Read-only community name
Read-only community name for SNMP agent

+ MQTT Settings

+ Server Settings

+ 3G/4G Data Connection

+ Disable Legacy Management Software

Save

Common SMTP Port numbers:
 Default: 25 (Not secure)
 TLS: 465 (Secure)
 STARTTLS: 587 (Secure)
 Contact your network administrator for required settings.

Use this button to send a test email to all configured users.

For maximum security for SNMP messages, use "SNMPv3"

Do NOT enable SNMPv3 if MQTT is enabled (page 87), use SNMPv1/v2c

VLAN Settings	Description
Enable 802.1Q VLAN	Select between "Disabled" (the default) or "Enabled"
VLAN ID	Enter a number between 0-4095 for your VLAN ID
SMTP Settings	
SMTP Server Type	Select either Custom, Gmail, or Office 365. Selecting Gmail or Office 365 will auto-select several fields.
SMTP Server	Enter a valid SMTP server name (e.g. yourcompany.com)
Port	Enter a valid port # (default port is 25, for TLS most use 465, for STARTTLS most use 587)
Email Format	Choose between sending emails in Plain Text format (the default) and HTML format
SMTP Encryption	Select between None, TLS or STARTTLS depending upon what your SMTP server supports
Use Authentication	Place a checkmark in the box if the SMTP server requires authentication to send email
Username	Enter a valid username to be used by the ENVIROMUX to send emails
Password	Enter a valid password assigned to the ENVIROMUX username
SNMP Settings	
Enable SNMP agent	Place a checkmark in the box to enable access to the SNMP agent. Choose between v1/v2c, v3 only (maximum security), or v1/v2c/v3.
SNMP Port	Enter desired SNMP port number for SNMP requests (default is 161)
Enable SNMP traps	Place a checkmark in the box to allow SNMP traps to be sent
Read-write community name	Enter applicable name (commonly used- "private")
Read-only community name	Enter applicable name (commonly used- "public")

VLAN Settings

The ENVIROMUX supports 802.1Q VLAN tagging (firmware version 2.52 and later) which can be used on managed switches to get more bandwidth and improved security. Any ID number between 0 and 4095 can be used.

Note: *If VLAN Tagging is enabled, the E-xD will drop out of the regular network (Native VLAN) and users won't be able to access it from an unmanaged switch. If the ID number is lost/forgotten, you can reset it by connecting to the ENVIROMUX through the serial port (page 74) or by using the "Restore Defaults" button (page 121) on the E-xD.*

Read-Only Community Name

The SNMP Read-only community name enables a user to retrieve "read-only" information from the ENVIROMUX using SNMP network management software or a MIB browser and a MIB file. This name must be present in the ENVIROMUX and in the proper field in the SNMP software. This name is **case sensitive** so be sure to enter it correctly in the ENVIROMUX as well as in the SNMP software.

Read-Write Community Name

The SNMP Read-Write community name enables a user to read information from the ENVIROMUX and to modify settings on the ENVIROMUX using SNMP network management software or a MIB browser and MIB file (MIB file version 1.05 or later). This name must be present in the ENVIROMUX **AND** in the proper field in the SNMP software. This name is **case sensitive** so be sure to enter it correctly in the ENVIROMUX as well as in the SNMP software.

This function is particularly useful if you want to control the state of the Output Relays (page 57) through SNMP. With the ENVIROMUX and SNMP network management software properly configured for SNMP control (enable agent, enable traps, apply Read-only and Read-write Community Names), a SET command can be sent either from the SNMP software or MIB browser (Windows) or through command line (Linux) to change the output Relay value state. See Figure 104 on page 90 for example of setup.

FQDN for Custom SMTP Server Type:

Some SMTP mailing server systems require having a valid FQDN (Fully Qualified Domain Name) when requesting to send e-mails. E-xD is set to use Enterprise Name, if set, as its FQDN. FQDN can be updated by changing Enterprise name on Administration > Enterprise Settings page, under Enterprise Setting option.

Gmail SMTP Server Type

If you select SMTP Server Type “Gmail”, the only thing left to do is enter the email format and the username of the Gmail account the ENVIROMUX will use to send alert messages.

Be sure the Username entered on the Enterprise page (page 77) matches the Gmail account name here.

Once these are entered, click on “**Authorize with Google**” and follow the prompts to authorize the ENVIROMUX to use that account. For more on this see “[How to Setup Email](#)”. Upon completion, the Current Status (below) should read “Authorization successful”.

NOTE: Device needs access to the Google servers (<https://accounts.google.com>, <https://www.googleapis.com>) to send emails. Additionally, device also needs access to the NTI server (<https://www.networktechinc.com>) during OAUTH setup. Ensure any firewall in between allows connections to Google and NTI servers from the device.

With a successful authorization, click the “**Send Test Email to All Users**” button and check an accessible user’s account to verify the feature is working.

Note: Test emails will only be sent to users that have email enabled (see page 94).

The screenshot displays the 'SMTP Settings' configuration interface. At the top, there is a section for 'SMTP Settings' with a collapse icon. Below this, the 'SMTP Server Type' is set to 'Gmail', with a dropdown menu and the instruction 'Select SMTP server to use for emails'. The 'Email Format' is set to 'Plain Text', with a dropdown menu and the instruction 'Email format'. The 'Username' field contains 'username@gmail.com' and is labeled 'Username for sending e-mails'. Below the settings, the 'Current Status' is 'Authorization successful'. There is an 'Authorize with Google' button with the text 'Authorize device to send emails using selected gmail account'. A 'Send Test Email to All Users' button is present, with a callout box pointing to it that reads: 'Use this button to send a test email to all configured users with email enabled.' Below the SMTP settings, there are sections for 'SNMP Settings', 'MQTT Settings', 'Server Settings', and '3G/4G Data Connection', each with a collapse icon. At the bottom left, there is a 'Save' button.

Figure 97- SMTP Settings- Gmail

Office 365 SMTP Server Type

When the Server Type is "Office 365", most of the rest of the settings are pre-selected for you. If you do not have an existing email address with Microsoft or a domain managed by Microsoft 365, please create and register a new Microsoft 365 account with Microsoft. Then enter that email address in the E-xD web interface for the SMTP Server Setting. That will be the email address that the ENVIROMUX will use to send out alert messages. Then click "Save" button.

SMTP Settings

SMTP Server Type
Select SMTP server to use for emails

Email Format
Email format

Username
Username for email authorization. For domains like Gmail/Office 365, username is the full email address. You may also have to set this email address in Administration -> Enterprise Settings

Current Status: Authorization not started



Authorize device to send emails using selected Office 365 account

Figure 98- Office 365 server settings- before authorization

After saving, Click the "Authorize with Microsoft" button to complete the process. For more on this see "[How to Setup Email](#)". Upon completion, the Current Status (below) should read "Authorization successful".

With a successful authorization, click the "Test Email" button and check an accessible user's account to verify the feature is working.

Note: Test emails will only be sent to users that have email enabled (see page 94).

Email Server Settings

Server Type
Select the type of Email server to use

E-mail
E-mail sender address for this unit

Current Status: Authorization successful



Authorize device to send emails using selected Microsoft account

Figure 99- Office 365 server settings- after authorization

+ SNMP Settings	
- MQTT Settings	
Enable MQTT	<input type="checkbox"/> Enable MQTT client connection
Client ID	<input type="text"/> Unique ID to identify client by the server
Server Address	<input type="text"/> Domain or IP address of the server
MQTT Port	<input type="text" value="1883"/> Port for MQTT connection. Usual Port #: 1883(non-secure), 8883(secure)
QoS level	<input type="text" value="QoS0"/> <input type="button" value="v"/> Select quality of service for message delivery (0: at most once, 1: at least once, 2: exactly once)
Username	<input type="text"/> Username for MQTT connection
Password	<input type="password" value="....."/> Password for MQTT connection
Encryption	<input type="text" value="DISABLED"/> <input type="button" value="v"/> Select encryption to use
Verify TLS certificate	<input type="checkbox"/> Checks and validates server certificate
Publish Interval	<input type="text" value="5"/> <input type="button" value="Sec"/> <input type="button" value="v"/> Select the interval at which sensor data is published (< 5 secs disables publication. NOTE: alert is always published when MQTT is enabled)
Publish Type	<input type="text" value="Individual Topic"/> <input type="button" value="v"/> Select the format to publish topic on
Topic Prefix	<input type="text"/> Optional prefix for standard E-xD topic
- Server Settings	
Enable Telnet	<input checked="" type="checkbox"/> Enable access to this device via telnet
Enable SSH	<input checked="" type="checkbox"/> Enable access to this device via ssh
Enable HTTP Access	<input checked="" type="checkbox"/> Enable access to this device via standard (non-secure) HTTP requests. HTTPS is always enabled.
HTTP Port	<input type="text" value="80"/> Port for standard HTTP requests
HTTPS Port	<input type="text" value="443"/> Port for HTTPS requests
Web Timeout	<input type="text" value="0"/> Minutes after which idle web users will be logged out (0 disables idle logout)
Console Timeout	<input type="text" value="0"/> Minutes after which idle console users will be logged out (0 disables idle logout)
Enable Modbus	<input type="checkbox"/> Enable access to this device via Modbus
Enable Fixed Modbus Address	<input type="checkbox"/> Enable fixed address blocks for external sensors instead of sequential addresses in Modbus
Modbus Port	<input type="text" value="502"/> Port for Modbus requests
Enable Network Security	<input type="checkbox"/> Disable ICMP response, no secure redirect when HTTP disabled, disable autofill of passwords, Enables HSTS
Use Secure Passwords Only	<input type="checkbox"/> Stores only secure passwords in config (Limits firmware downgrade options)
Disable Legacy Management Software	<input type="checkbox"/> Disable legacy Management Software E-MNG which uses port 6000 on E-xD
+ 3G/4G Data Connection	

If the ENVIROMUX is going to be behind a firewall (router) ensure the ports needed are set to open for network access. See complete list of ports on page 130.

Figure 100- Configure MQTT and Server Settings

MQTT Settings	
Enable MQTT	Place a checkmark in the box to enable MQTT By default MQTT is disabled. Note: Do NOT enable MQTT if SNMPv3 is enabled (page 82).
Client ID	This will be auto-generated with a unique ID by default
Server Address	Enter a valid IP address or domain for the MQTT server
MQTT Port	Enter port number the MQTT server is listening on
QoS Level	Select the quality of service for the message level; 0 (at most once) 1 (at least once), 2 (exactly once)
Username	Enter a username for MQTT connection
Password	Enter a password for MQTT connection
Encryption	Encryption can be Disabled or use TLS 1.0, TLS 1.1 or TLS 1.2,
Verify TLS Certificate	Enter checkmark to verify server signature and peername in the certificate using uploaded root certificate.
Publish Interval	Select the interval at which sensor data is published and choose seconds or minutes (< 5 secs disables publication. NOTE: alert is always published when MQTT is enabled)
Publish Type	Select between publishing Individual Topic or Bulk Topic (see below for link to MQTT instruction)
Topic Prefix	Optional prefix for standard E-xD topic (May be left empty)

QoS level - Quality of service, determines message delivery agreement

QoS0: At most once (no guarantee that message is delivered)

QoS1: At least once (message delivery guaranteed but could be delivered multiple times)

QoS2: Exactly once (message delivery guaranteed, only one delivery)

Username and password - MQTT server settings determine if user/password authentication is required

Verify TLS certificate - selecting this will check and validate both server certificate and peername.

NOTE: Server has it's own settings to request and validate certificate, if certificate is requested then ExD will send uploaded certificates. See page 106 or "[How to Create x509 Certificate](#)" for more information.

Topic Prefix - Optional prefix to use for ExD standard topics. (May be left empty) By default the prefix is populated with "ExD<mac_address>". This can be multi-level if desired (ExD0C820F0708/buildingA/, the trailing forward slash is automatically added if not present).

"Topic Prefix" field in MQTT settings is always pre-applied to the topic.

For examples of the published messages using the MQTT protocol, see "[How to Setup MQTT Communication](#)" .

Server Settings	
Enable Telnet	Place a checkmark in the box to enable access to the ENVIROMUX via Telnet By default Telnet is disabled.
Enable SSH	Place a checkmark in the box to enable access to the ENVIROMUX via SSH
Enable HTTP access	Place a checkmark in the box to enable access to the ENVIROMUX via standard (non-secure) HTTP requests. If the checkbox is deselected, the ENVIROMUX unit will disable HTTP access. The unit's webpage will remain accessible via HTTPS. Don't disable until you read the notes below.
HTTP Port	Port to be used for standard HTTP requests.
HTTPS Port	Port to be used for HTTPS requests
Web Timeout	Number of minutes after which idle web uses will be logged-out (enter 0 to disable this feature)
Console Timeout	Number of minutes after which idle console user will be logged-out (minimum is 1 to enable the feature or enter 0 to disable this feature). This setting effects Console, Telnet and SSH connections.
Enable Modbus	Place a checkmark in the box to enable access via Modbus software
Enable Fixed Modbus Address	Place a checkmark to enable fixed address block for each of the RJ45 sensor ports
Modbus Port	Enter a valid port number to be used to communicate via Modbus (default is 502)
Enable Network Security	Place a checkmark here to disable ICMP responses, disable autofill and auto saving of passwords. Redirect HTTP to HTTPS using HSTS. If "Enable HTTP access" is unchecked also, then port 80 will be completely disabled.
Use Secure Passwords Only	Place a checkmark in the box if you want all passwords that get saved to a configuration download to be encrypted within that file. Note: While this is enabled, you will not be able to perform a firmware downgrade to an earlier firmware version. To downgrade to an earlier version, remove the checkmark from this box.

Note: When using only a secure access configuration ("Enable HTTP Access" is NOT checked), if you intend to connect to the ENVIROMUX from a location outside the local area network, make sure the firewall on the local area network is configured to allow traffic through the port assigned to HTTPS requests.

Note: If you are installing the ENVIROMUX with a public IP address and intend to use only a secure access configuration, you will need to create an x.509 certificate (page 106) and load it into the ENVIROMUX and any PC that will be required to access the ENVIROMUX.

3G/4G Data Connection

Enable 3G/4G Data	Disabled <input type="button" value="v"/> <small>Enable 3G/4G Modem data connection</small>
Enable 3G/4G as primary route	Disabled <input type="button" value="v"/> <small>Make Modem data connection as primary route</small>
APN	<input type="text"/> <small>Service providers APN</small>
Dial String	<input type="text"/> <small>Dial string for data connection</small>
Username	<input type="text"/> <small>Username for data connection. Can be empty.</small>
Password	<input type="password" value="*****"/> <small>Password for data connection. Can be empty.</small>

Figure 101- Configure 3G/4G Data Connection

3G/4G Data Connection	
Enable 3G/4G Data	Enable if you want the option to have the ENVIROMUX send alert messages through the USB modem and the option to access the web interface using the IP address assigned to the SIM card account. The default is disabled. NOTE: In order to access the web interface through the modem, the SIM card must have a "public" IP address (page 19).
Enable 3G/4G as primary route	Enable if you want all messages that are sent by the ENVIROMUX to go through the modem connection instead of the Ethernet. The default setting is disabled. Note: If this feature is enabled, and then later disabled, the ENVIROMUX must be rebooted to reset outgoing messaging parameters.
APN	Enter the APN address of the service provider (provided by the service provider)
Dial String	Enter the dial string required for data connection(provided by the service provider)
Username	Enter the username supplied by service provider for access to connection. Leave blank if no username is required.
Password	Enter the password supplied by service provider for access to connection. Leave blank if no password is required.

If the administrator chooses to have the IP and DNS information filled in automatically via DHCP, the SMTP server and port number still need to be entered for email alerts to work. If the SMTP server requires a password in order for users to send emails, the network administrator must first assign a user name and password to the ENVIROMUX.

Note: The most common SMTP server port number is 25, but it is not necessarily the port number assigned to your SMTP server. For SMTP servers that support TLS, the common port number is 465, and for those that support STARTTLS, the common port number is 587.

The administrator may assign a different HTTP Server Port than is used by most servers (80). This might be desired if the administrator wants a secure connection.

Note: If the port number is changed and forgotten, to determine what it has been changed to connect the ENVIROMUX for RS232 control (page 16) and review the Network Settings (page 81).

If the SMTP server supports STARTTLS or TLS (user authentication), select the protocol as appropriate.

Note: If the 3G Data connection is enabled as the primary internet connection, make sure that a reliable signal exists between the modem and service provider. Otherwise attempts made by the ENVIROMUX to communicate with devices on the network may be delayed and cause unnecessary alert messages.

For a guide to setting up the ENVIROMUX for sending email messages, see [How to Setup Email](#). For assistance in setting up SNMP messaging, see [How to Setup SNMP](#).

For a complete list of ENVIROMUX factory-assigned port numbers, see page 130.

DDNS Settings

The ENVIROMUX supports DDNS services with many providers, for example No-IP, Dydns and FreeDNS. (See list of known providers on page 130) Any provider compatible with inadyn daemon will work with the E-xD. For general information on inadyn go to <https://github.com/troglobit/inadyn>.

Simply enable the support, enter a value in seconds (range is 30-764000) for the Update Period, enter the DDNS service provider and other required pieces of information indicated below.

The Update Period determines how often the ENVIROMUX will check with the DDNS provider to verify that it has the correct IP address associated with the DDNS hostname. If the IP address they have is different than that in the ENVIROMUX, the recorded IP address will be updated with the IP address in the ENVIROMUX.

DDNS Settings	
Enable DDNS	<input type="text" value="Enabled"/> <small>Enable/Disable DDNS</small>
Period	<input type="text" value="60"/> <small>Update Period</small>
Provider	<input type="text" value="freedns"/> <small>DDNS Provider</small>
User Name	<input type="text" value="ntidnstest"/> <small>DDNS User Name</small>
Password	<input type="text" value="yourchoice"/> <small>DDNS Password</small>
Hostname	<input type="text" value="ntie5d.ignorelist.com"/> <small>DDNS Hostname</small>

Figure 102- DDNS Settings

Disable Legacy Management Software

Legacy E-MNG Management software uses port 6000 to communicate with E-xD devices. If you do not wish to use Legacy E-MNG Management software then place a checkmark in "Disable Manager Port". Instead, if you are using the NTI E-MNG-SH Self-Hosted Management Software, disabling this Manager Port has no effect on that software as it uses HTTP/HTTPS communication.

Disable Legacy Management Software	
Disable Manager Port	<input type="checkbox"/> <small>Manager Port 6000 and its features will be inaccessible</small>

Figure 103- Disable Legacy Management Software

SNMP Settings

Enable SNMP Agent SNMPv1v2c/v3
Allow access to SNMP agent on this device

Enable SNMP Traps
Enable sending of SNMP traps from this device

Read-write community name private
Read-write community name for SNMP agent

Read-only community name public
Read-only community name for SNMP agent

1. Configure the ENVIROMUX (Network Settings)

Note: enter same values from ENVIROMUX to the MIB browser

Options

General | Default Values | Agents | MIB Files

IP Address	Port	Version	Read Community	Write Community	User	Auth
192.168.3.100	161	1	***** (public)	***** (private)		MD5

2. Configure the MIB browser

iReasoning MIB Browser

Address: 98.17.207.204 | Advanced... | OID: .1.3.6.1.4.1.3699.1.1.6.1.7.1.1.5.1 | Operations: Get Next | Go

MIB Tree

- iso.org.dod.internet.private.enterprises.nti.products
 - hardware
 - ipdusx
 - masterUnit
 - hostSystem
 - users
 - groups
 - intSensors
 - extSensors
 - rlyOutputs
 - rlyOutputTable
 - rlyOutputEntry
 - rlyOutputIndex
 - rlyOutputDescription
 - rlyOutputGroupNb
 - rlyOutputGroup
 - rlyOutputValue
 - rlyOutputNormalValue
 - ipDevices
 - envGroups
 - envTraps
 - enviromux16D
 - otherProduct
 - software
 - ...

Result Table

| Name/OID | Value | Type | IP:Port |
|------------------|---------|---------|----------------|
| rlyOutputValue.1 | on (1) | Integer | 98.17.207.2... |
| rlyOutputValue.2 | on (1) | Integer | 98.17.207.2... |
| rlyOutputValue.3 | on (1) | Integer | 98.17.207.2... |
| rlyOutputValue.4 | on (1) | Integer | 98.17.207.2... |
| rlyOutputValue.5 | on (1) | Integer | 98.17.207.2... |
| rlyOutputValue.6 | on (1) | Integer | 98.17.207.2... |
| rlyOutputValue.7 | off (0) | Integer | 98.17.207.2... |
| rlyOutputValue.8 | off (0) | Integer | 98.17.207.2... |

3. Expand the tree to view the relay output values (right click -> Get Subtree)

4. Identify which Output to change state (power On or power Off), right click and choose Set

5. Change "Value" to 1 (for On) or 0 (for Off). Click "OK".

6. Confirmation of state change.

ENVIROMUX operating system CPU and memory usage data can be viewed if the UCD-SNMP-MIB is loaded (firmware version 2.16 or later required). See <https://www.networktechinc.com/pdf/sman154-05.pdf>.

SNMP SET

OID: .1.3.6.1.4.1.3699.1.1.6.1.7.1.1.5.1

Data Type: Integer

Value: 0

Ok | Cancel

SET succeeded

SET succeeded

OK

Figure 104- How to setup SNMP to control output relays

User Configuration

The Users page is a list of all configured users of the ENVIROMUX. A maximum of 16 users (other than root) can be configured. From this page the root user (or any user with administrator rights) can choose to add more users, go to the user configuration page to edit a user's access to the ENVIROMUX, or delete a user from the list. A user with Operator rights can perform some administrative functions, but not all. (See page 98). To view the Users page, click on **Users** from the **Administration** section of the menu.

Users

| No. | Username | Enabled | Admin | Operator | Last Login | Action |
|-----|-----------------------------|---------|-------|----------|------------------------|---|
| 1 | root | yes | yes | yes | 01-22-2018 08:43:22 AM | Edit |
| 2 | Test | yes | yes | yes | 03-09-2015 04:30:10 PM | Edit Delete |
| 3 | Verizon SMS | yes | no | no | Never | Edit Delete |
| 4 | Test2 | yes | no | no | Never | Edit Delete |
| 5 | guesta | yes | no | no | 01-12-2018 05:40:15 PM | Edit Delete |
| 6 | oper | yes | no | yes | 01-17-2018 11:25:23 AM | Edit Delete |

[Add New User](#)

Figure 105- Usernames List and Status

To add a user, click on the "Add New User" link.

To edit a user's configuration, either click on the listed username, or on the "Edit" link.

To delete a user and their configuration, click on "Delete" link.

When adding a new user, the Configure User page will open with the username "userx" assigned, where x = the next consecutive number (up to 16) based on the quantity of users in the list (other than the root user). You can either leave the name as "userx", or change it to what you would like to see listed. With the name assigned, fill in the remaining information as needed.

Note: The username "root" can also be changed, however, if the name it is changed to is forgotten, you will need to login as another administrative user to see or make changes to it. Failing that, to restore administrative access you will need to press the "Restore Defaults" button on the front of the ENVIROMUX.

Configure User

[-] Account Settings

| | |
|-------------------|--|
| Username | <input type="text" value="Test"/>
<small>The username for this user</small> |
| Admin | <input checked="" type="checkbox"/> Grant this user administrative privileges |
| Operator | <input type="checkbox"/> Grant this user operator privileges |
| Enabled | <input checked="" type="checkbox"/> Users can only access the system if their account is enabled |
| Password | <input type="password" value="*****"/>
<small>The user's password to login to the system (for local authentication)</small> |
| Confirm | <input type="password" value="*****"/>
<small>Confirm the entered password</small> |
| Title | <input type="text" value="Test Account"/>
<small>The user's title within the company</small> |
| Department | <input type="text" value="Engineering"/>
<small>The user's department within the company</small> |
| Company | <input type="text" value="NTI"/>
<small>The name of the user's company</small> |

[+] Group Settings

[+] LDAP Account Settings

[+] Contact Settings

[+] Schedule Settings

[+] SNMP Settings

Figure 106- Edit user profile for root user

| Group Settings | |
|----------------|---|
| Group #01 | <input checked="" type="checkbox"/> User receives notifications for Group 1 |
| Group #02 | <input checked="" type="checkbox"/> User receives notifications for Group 2 |
| Group #03 | <input checked="" type="checkbox"/> User receives notifications for Group 3 |
| Group #04 | <input checked="" type="checkbox"/> User receives notifications for Group 4 |
| Group #05 | <input checked="" type="checkbox"/> User receives notifications for Group 5 |
| Group #06 | <input checked="" type="checkbox"/> User receives notifications for Group 6 |
| Group #07 | <input checked="" type="checkbox"/> User receives notifications for Group 7 |
| Group #08 | <input checked="" type="checkbox"/> User receives notifications for Group 8 |

| LDAP Account Settings | |
|--------------------------------|--|
| Common Name (for LDAP) | <input type="text"/>
The Common Name for the user in an Active Directory |
| Organizational Unit (for LDAP) | <input type="text"/>
The Organizational Unit the user belongs to in an Active Directory |

| Contact Settings | |
|------------------------|--|
| E-mail Alerts | <input type="checkbox"/> User receives alerts via e-mail |
| Brief E-mail | <input type="checkbox"/> User receives brief e-mail |
| E-mail Address 1 | <input type="text" value="user@ntigo.com"/>
E-mail address 1 for the user |
| E-mail Address 2 | <input type="text"/>
E-mail address 2 for the user |
| E-mail Address 3 | <input type="text"/>
E-mail address 3 for the user |
| E-mail Address 4 | <input type="text"/>
E-mail address 4 for the user |
| Sound Alerts | <input type="checkbox"/> Enable alert sounds when monitoring on web page |
| Syslog Notifications | <input checked="" type="checkbox"/> Receives Event Logs messages via syslog including sensor alerts and non sensor alerts |
| Syslog Port | <input type="text" value="514"/>
select syslog port to be used |
| Syslog Facility | <input type="text" value="Local.0"/> 
Select the user's syslog facility |
| SNMP Traps | <input checked="" type="checkbox"/> User receives alerts via SNMP traps |
| SNMP Trap Port | <input type="text" value="162"/>
Select SNMP Trap port to be used. Usual Port |
| Syslog/SNMP IP Address | <input type="text"/>
IP address where syslog messages/SNMP traps are sent for this user |
| SMS Alerts | <input type="checkbox"/> User receives alerts via SMS |
| SMS Number 1 | <input type="text"/>
Phone number 1 where SMS messages are sent for this user |
| SMS Number 2 | <input type="text"/>
Phone number 2 where SMS messages are sent for this user |
| SMS Number 3 | <input type="text"/>
Phone number 3 where SMS messages are sent for this user |
| SMS Number 4 | <input type="text"/>
Phone number 4 where SMS messages are sent for this user |

Figure 107- More user settings

| Account Settings | Description |
|--------------------------------|--|
| Username | Enter the desired username for this user |
| Admin | Place a checkmark here if this user should have administrative privileges |
| Operator | Place a checkmark here if this user should have operator privileges |
| Enabled | Place a checkmark here to enable this user to access the ENVIROMUX |
| Password | Enter a password that a user must use to login to the system
A password must be assigned for the user's login to be valid
Passwords must be at least 1 keyboard character. |
| Confirm | Re-enter a password that a user must use to login to the system |
| Title | Enter information as applicable |
| Department | Enter information as applicable |
| Company | Enter information as applicable |
| Group Settings | |
| Group 1-8 | Place a checkmark if the user should receive messages from sensors, accessories, or IP devices in Group 1, 2, 3... thru 8 (see also pages 44 and 60 for group assignments) |
| LDAP Account Settings | |
| Common Name (for LDAP) | "Common Name" assigned in the LDAP server account in an Active Directory. Often a name assigned that is different than the Username. If this is the same as the Username in the "Account Settings" (above), this can be left blank. |
| Organizational Unit (for LDAP) | Enter the Organizational Unit the user belongs to in an Active Directory
Format is <ou,ou,etc> |
| Contact Settings | |
| Email alerts | Place a checkmark if the user should receive messages via email |
| Brief email | Place a checkmark if email messages should be brief (contain only critical information)
Note: Enabling this will also prevent images being sent from IP cameras to this user |
| Email address (1-4) | Enter up to four valid email addresses if this user should receive email alert messages (maximum 63 characters)
Tip: The user can receive alert messages to their cell phone (SMS) by entering the cell carrier's email address here (i.e. 1234567890@pushover.net) in the absence of a modem. |
| Sound Alerts | Place a checkmark if the user wants to be notified of an alert through their PC with an audible sound. User must be logged in to the Web Interface and the Summary Page displayed. |
| Syslog Notifications | Place a checkmark if the user should receive event log messages via syslog including sensor alerts and non-sensor alerts |
| Syslog Port | Enter the port number to be used to receive syslog messages (default is 514) |
| Syslog facility | Select a Syslog Facility for the messages to be sent to- Local0 thru Local7 (default is Local0). |
| SNMP Traps | Place a checkmark if the user should receive alerts via SNMP traps |
| SNMP Trap Port | Enter the port the user will receive SNMP traps on (default is 162) |
| Syslog/SNMP IP address | Enter a valid syslog/SNMP IP address for the user to receive syslog/SNMP messages |
| SMS Alerts | Place a checkmark if the user should receive alerts via SMS messages (requires a modem) |
| SMS Number (1-4) | Enter up to 4 different phone numbers to call to alert the user via SMS message |

Schedule Settings

The Schedule Settings section provides the user with extensive control over the days and times that alert messages can be received. Time periods are in the 24HR format starting with 0 (12:00 to 1:00 a.m.) and each day of the week can be defined separately. Additionally, an extra control is provided for separate scheduling to occur on holidays, defined under System Configuration (page 73). By default, all time periods are enabled.

| Schedule Settings | | AM | | | | | | | | | | | | PM | | | | | | | | | | | |
|-------------------|-----|----|---|---|---|---|---|---|---|---|---|----|----|----|----|----|----|----|----|----|----|----|----|----|----|
| TIME | DAY | 0 | 1 | 2 | 3 | 4 | 5 | 6 | 7 | 8 | 9 | 10 | 11 | 12 | 13 | 14 | 15 | 16 | 17 | 18 | 19 | 20 | 21 | 22 | 23 |
| SUNDAY | | | | | | | | | | | | | | | | | | | | | | | | | |
| MONDAY | | | | | | | | | | | | | | | | | | | | | | | | | |
| TUESDAY | | | | | | | | | | | | | | | | | | | | | | | | | |
| WEDNESDAY | | | | | | | | | | | | | | | | | | | | | | | | | |
| THURSDAY | | | | | | | | | | | | | | | | | | | | | | | | | |
| FRIDAY | | | | | | | | | | | | | | | | | | | | | | | | | |
| SATURDAY | | | | | | | | | | | | | | | | | | | | | | | | | |
| HOLIDAY | | | | | | | | | | | | | | | | | | | | | | | | | |

On
 Partially On
 Off. Press and hold to select 15 min periods
 Reset

Figure 108- Schedule Settings for users

Dark green blocks indicate time periods when messages are enabled to be received by the user.

White blocks indicate time periods where messages are disabled and no messages will be received by that user.

Light green blocks indicated time periods where part of that hour is configured to receive messages, and part of it is configured to not receive messages.

| Schedule Settings | | AM | | | | | | | | | | | | PM | | | | | | | | | | | |
|-------------------|-----|----|---|---|---|---|---|---|---|---|---|----|----|----|----|----|----|----|----|----|----|----|----|----|----|
| TIME | DAY | 0 | 1 | 2 | 3 | 4 | 5 | 6 | 7 | 8 | 9 | 10 | 11 | 12 | 13 | 14 | 15 | 16 | 17 | 18 | 19 | 20 | 21 | 22 | 23 |
| SUNDAY | | | | | | | | | | | | | | | | | | | | | | | | | |
| MONDAY | | | | | | | | | | | | | | | | | | | | | | | | | |
| TUESDAY | | | | | | | | | | | | | | | | | | | | | | | | | |
| WEDNESDAY | | | | | | | | | | | | | | | | | | | | | | | | | |
| THURSDAY | | | | | | | | | | | | | | | | | | | | | | | | | |
| FRIDAY | | | | | | | | | | | | | | | | | | | | | | | | | |
| SATURDAY | | | | | | | | | | | | | | | | | | | | | | | | | |
| HOLIDAY | | | | | | | | | | | | | | | | | | | | | | | | | |

On
 Partially On
 Off. Press and hold to select 15 min periods
 Reset

Figure 109- Colored blocks indicate variations in settings

To disable messages for the entire hour, simply click on the block. To change it back, click it again.

To disable messages for several hours, click and drag several blocks in either direction (left-to-right for over the same day, or up-and-down for the same hour over several days). Click and drag again to change it back.

Be sure to click "Save" at the bottom of the page to save your changes before leaving this page.

If you leave the page without saving, no changes will be saved.

To Disable messages for a user for the whole day with one click, just click on the day of the week.

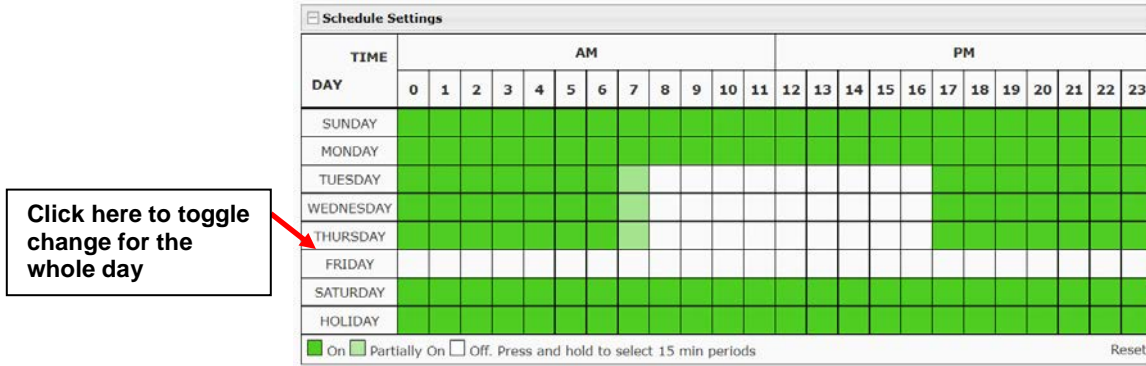

Figure 110- Disable messages for an entire day

Or for the same hour in the entire schedule, just click on the hour of the day.

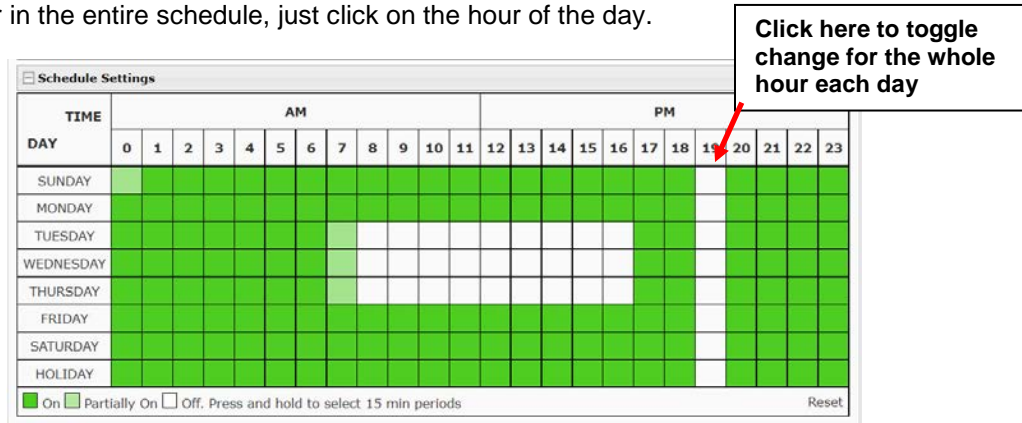

Figure 111- Disable messages for the same hour every day

To control the time period down to 15 minute increments (turning the block light green), click and hold a block. Then select the 15 minute period(s) where messages will be enabled vs. disabled for that user.

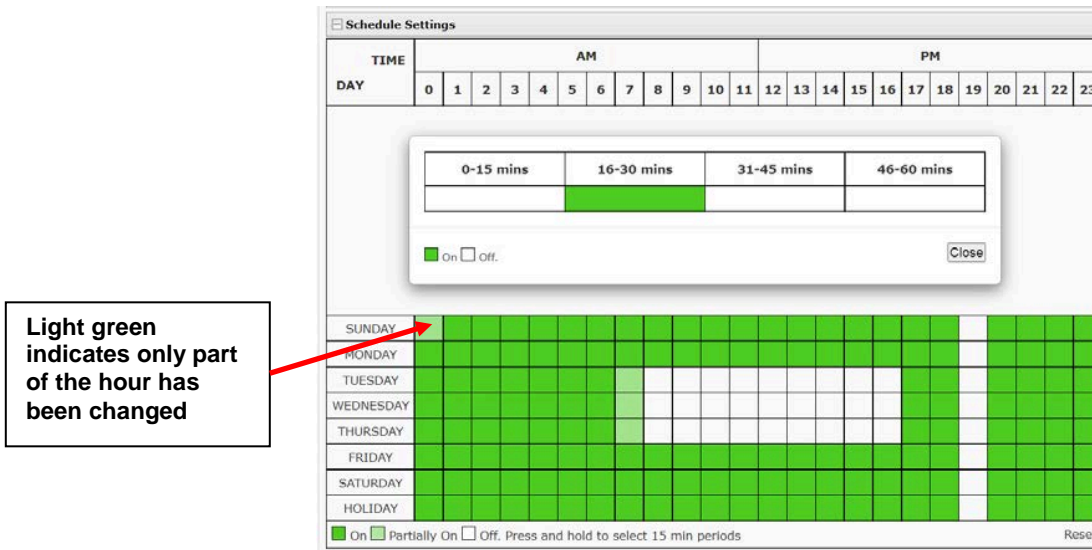

Figure 112- Select 15 minute increments of control over messages

Be sure to click "Save" at the bottom of the page to save your changes before leaving this page.

If you leave the page without saving, no changes will be saved.

[-] SNMP Settings

| | |
|----------------------------------|---|
| Authentication Protocol | <div style="border: 1px solid #ccc; padding: 2px; display: inline-block;">None ▾</div>
<small>Select authentication protocol</small> |
| Authentication Passphrase | <div style="border: 1px solid #ccc; padding: 2px; display: inline-block;">12345678</div>
<small>The authentication passphrase</small> |
| Privacy Protocol | <div style="border: 1px solid #ccc; padding: 2px; display: inline-block;">None ▾</div>
<small>Select privacy protocol</small> |
| Privacy Passphrase | <div style="border: 1px solid #ccc; padding: 2px; display: inline-block;">12345678</div>
<small>The privacy passphrase</small> |
| Traps Type | <div style="border: 1px solid #ccc; padding: 2px; display: inline-block;">SNMPv2c ▾</div>
<small>Select type of traps accepted by user</small> |

Figure 113- More user settings

| SNMP Settings | |
|---------------------------|--|
| Authentication Protocol | Choose between MD5 or SHA to require authentication, or none to disable it |
| Authentication Passphrase | Assign the passphrase to be used to enable the receipt of SNMP v3 messages |
| Privacy Protocol | Choose between DES or AES (v128) to encrypt SNMP readings or traps or "None" to disable encryption. If encryption is enabled, then the Authentication Protocol must also be set at "MD5" or "SHA". |
| Privacy Passphrase | Assign the passphrase to be used to open and read readings or alert messages received via SNMP v3 |
| Traps Type | Choose between SNMPv1, SNMPv2C, or SNMPv3 |

After changing any settings in the user profile, press "Save".

If a user is set with only "User" rights instead of "Administrator" rights, the user will only be able to see current sensor readings and to change their password if so desired. No other ENVIROMUX access is possible.

Note: If the root user's password is changed and forgotten, contact Network Technologies Inc at (800) 742-8324 (800-RGB-TECH) or (330) 562-7070 for assistance.

Note: Each user can have only one email address (maximum 63 characters) associated with that user. If an additional email address is needed, an additional user must be added with the desired email address. As long as both users are configured to get messages from the same sensor groups, both email addresses will get the same alert messages. For more on users and sensor groups, see page 45.

More about User Privileges

The root user (or any user with administrator rights) can change the root password and configure how the root user will receive alert messages. Users with **administrative** rights can change all configuration settings except for the root user name.

The user with Operator privileges has fewer rights than an administrator but more rights than just the basic user rights. Operator privileges include:

- Ability to view alerts, acknowledge alerts and dismiss alerts of all Internal and External sensors.
- Ability to control output relays
- Ability to cycle the sensor power on digital inputs.
- Ability to view and download logs.
- Ability to reboot the unit.

Users with **user** rights can only see the current readings of monitored items and change their own passwords.

Home Summary

Monitoring
Administration
Log
Support
Logout

Summary

Sensors

| Conn. | Description | Type | Value | Status | Action |
|-------|---|-------------------|-------|--------|--|
| 1 | Server Rack Temperature | Temperature Combo | 86.9F | Normal | View Edit Delete |
| 1 | Server Rack Humidity | Humidity Combo | 26.6% | Normal | View Edit Delete |
| 2 | Server Room Temperature | Temperature Combo | 76.8F | Normal | View Edit Delete |
| 2 | Server Room Humidity | Humidity Combo | 34.1% | Normal | View Edit Delete |

Water Sensors

| Conn. | Description | Type | Value | Status | Action |
|-------|---|--------------|-------|--------|---|
| 1 | Server Room Water Detection | Water Sensor | Open | Normal | View Edit |

Dry Contacts

| Conn. | Description | Type | Value | Status | Action |
|-------|--|-------------|-------|--------|---|
| 1 | Server Room Smoke Detector | Dry Contact | Open | Normal | View Edit |
| 2 | Server Room Door | Dry Contact | Open | Normal | View Edit |
| 3 | Not Used | Dry Contact | Open | Normal | View Edit |
| 4 | Not Used | Dry Contact | Open | Normal | View Edit |

IP Devices

| Num. | Description | Type | Value | Status | Action |
|------|-------------------------------|-----------|------------|--------|--|
| 1 | Web Server | IP Device | Responding | Normal | View Edit Delete |
| 2 | Backup Server | IP Device | Responding | Normal | View Edit Delete |

Copyright © 2011 Network Technologies Inc. All rights reserved.

Figure 114-Summary page for User without Admin privileges

Maps Config

Up to 3 map images can be uploaded to the ENVIROMUX. Images must be .jpg format, with a maximum size of 850px x 605px. We recommend using images that are 750px x 505px.

1. To setup a map, first locate the image file to be uploaded (must be .jpg format). Then click "Upload".
2. Once uploaded, click on the map to have it enlarge in the viewing window.
3. All available sensors monitored by the ENVIROMUX will be listed under "Available Sensor List". Choose a sensor and its location in your map.
4. Select and drag the sensor from list to the location and release the mouse button. A green dot will now represent the sensor on the map, and the sensor will no longer be in the "Available Sensor List" for that map.

The screenshot shows the 'Maps Config' interface. At the top, three map thumbnails are displayed: 'Map 1' (server room), 'Map 2' (server rack), and 'Map 3' (black). A red arrow points to 'Map 1' with the label 'Selected map'. Below the thumbnails, a larger view of 'Map 1' is shown, with a red arrow pointing to it labeled 'Selected map enlarged in viewing window'. In this enlarged view, several green dots are placed on the server racks, with a red arrow pointing to one labeled 'Sensor indicated by green dot'. At the bottom right of the map view, a red arrow points to a 'Delete map' button with the label 'To remove a map and all sensor locations indicated, click on "Delete map"'. Below the map view, there is a text field for 'Recommended size: 750px X 505px', an 'Upload/Replace Map' section with a 'Choose File' button and 'No file chosen' text, and 'Upload' and 'Delete map' buttons. Below this is an 'Available Sensor List' table with the following items:

| |
|------------------------------------|
| E-5DEL-1 Internal Temperature |
| Remote 5D Internal Temperature |
| Remote 5D Internal Humidity |
| Remote 5D Battery Voltage |
| E-5DEL-1 STHSB Port 1 Dew_Point |
| E-5DEL-1 STHS-LCD Port 2 Dew_Point |
| E-5DEL-1 STHSB Port 3 Humidity |
| E-5DEL-1 STHSB Port 3 Dew_Point |
| E-5DEL-1 IMDM Port 5 Motion |

At the bottom center, there is a 'Save Configuration' button.

Figure 115- Maps Configuration page

If you try to upload an image that is too large, you will receive the message "Please upload a map smaller than 850x605px".

Recommended size: 750px X 505px

Please upload a map smaller than 850X605px for map 3

Upload/Replace Map : No file chosen

From the Maps Config screen in the Administration menu, if you hover over a sensor, the name of that sensor will appear. If you wish to delete the sensor from the map, click "Delete".

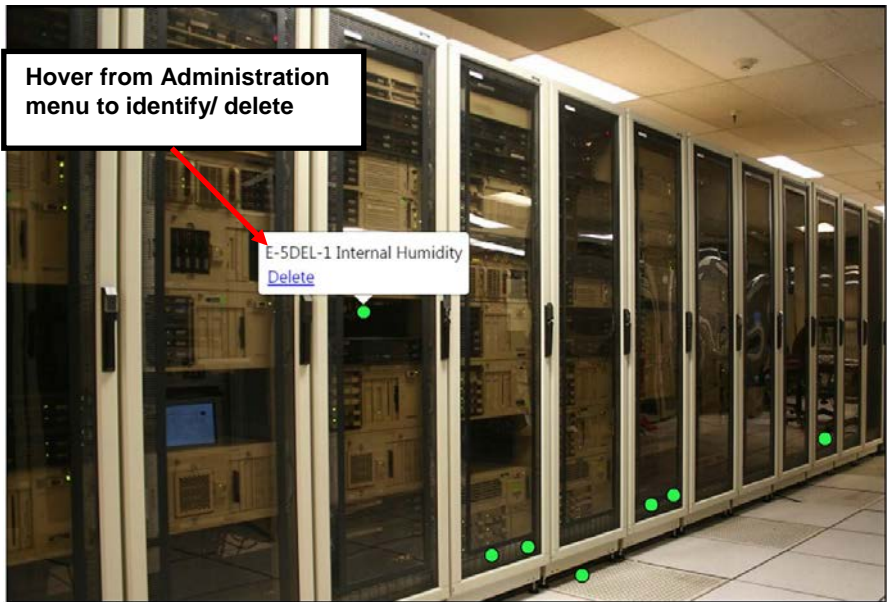

Figure 116- View from Administration menu

From the Maps screen in the Monitoring menu (page 31), if you hover over a sensor, you will see the status of that sensor and if you click on it you will go view the status page or click Edit and open the configuration page.

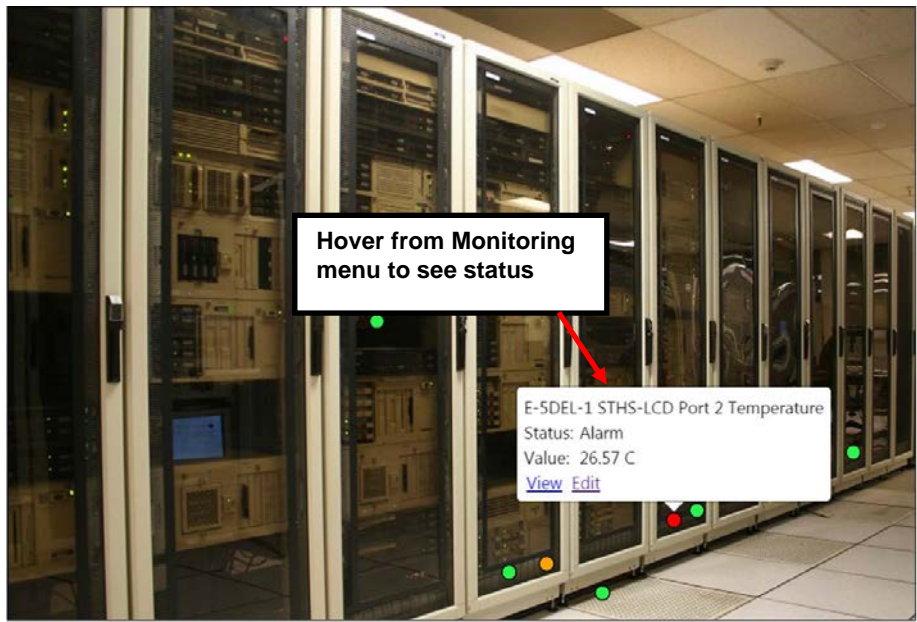

Figure 117- View from Monitoring menu

Sensors in a normal state are green. Sensors in a Warning state (within the range of sensing values between the non-critical threshold value and the critical threshold value, but not yet in alert) will turn Orange. Sensors in Alert state will turn Red.

Note: Sensors in warning or alert condition will only be viewable from Maps in the Monitoring menu.

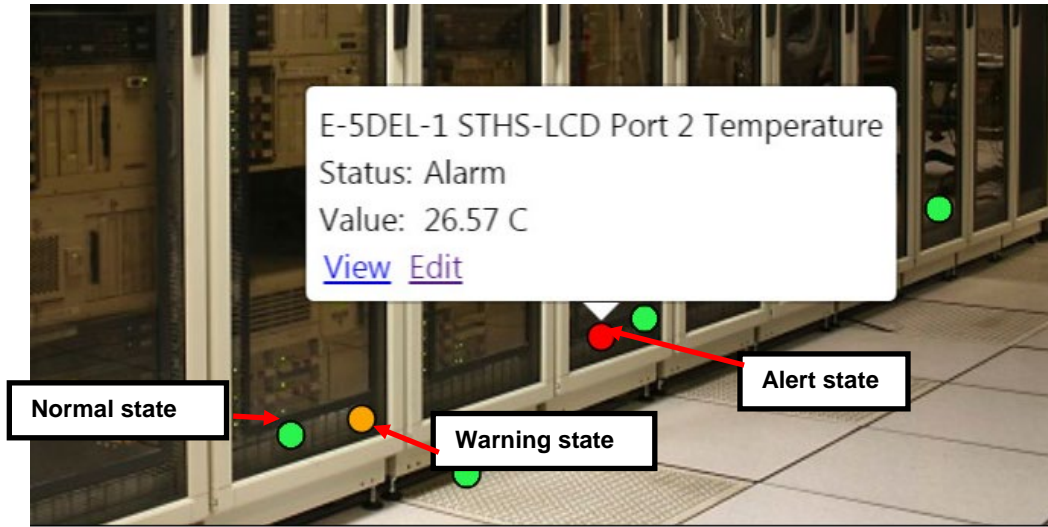

Figure 118- Sensors on map in different states

Group Names

Group names can be applied instead of the group numbers in the event an association is desired other than “Group 0x” . For each group (1-8), a name can be applied containing up to 64 English or 21 Kanji (Japanese) characters.

Group Names

| | |
|-----------|--|
| Group #1: | <input type="text" value="Group #01"/> |
| Group #2: | <input type="text" value="Group #02"/> |
| Group #3: | <input type="text" value="Group #03"/> |
| Group #4: | <input type="text" value="Group #04"/> |
| Group #5: | <input type="text" value="Group #05"/> |
| Group #6: | <input type="text" value="Group #06"/> |
| Group #7: | <input type="text" value="Group #07"/> |
| Group #8: | <input type="text" value="Group #08"/> |

Figure 119- Enter custom group names

Security

Access to the web interface on the ENVIROMUX can be through standard methods (enable HTTP access- page 88) or limited to secure access only (disable HTTP access and only allow HTTPS access which is always enabled by default). Security in the ENVIROMUX can be managed one of three ways; through the local settings (passwords assigned in user settings on page 94), through an LDAP server or through a RADIUS server. If security is configured to use LDAP mode, then the names for users must be the same as those found on a configured LDAP server. To view the Security Configuration page, select **Security** in the **Administration** section of the menu.

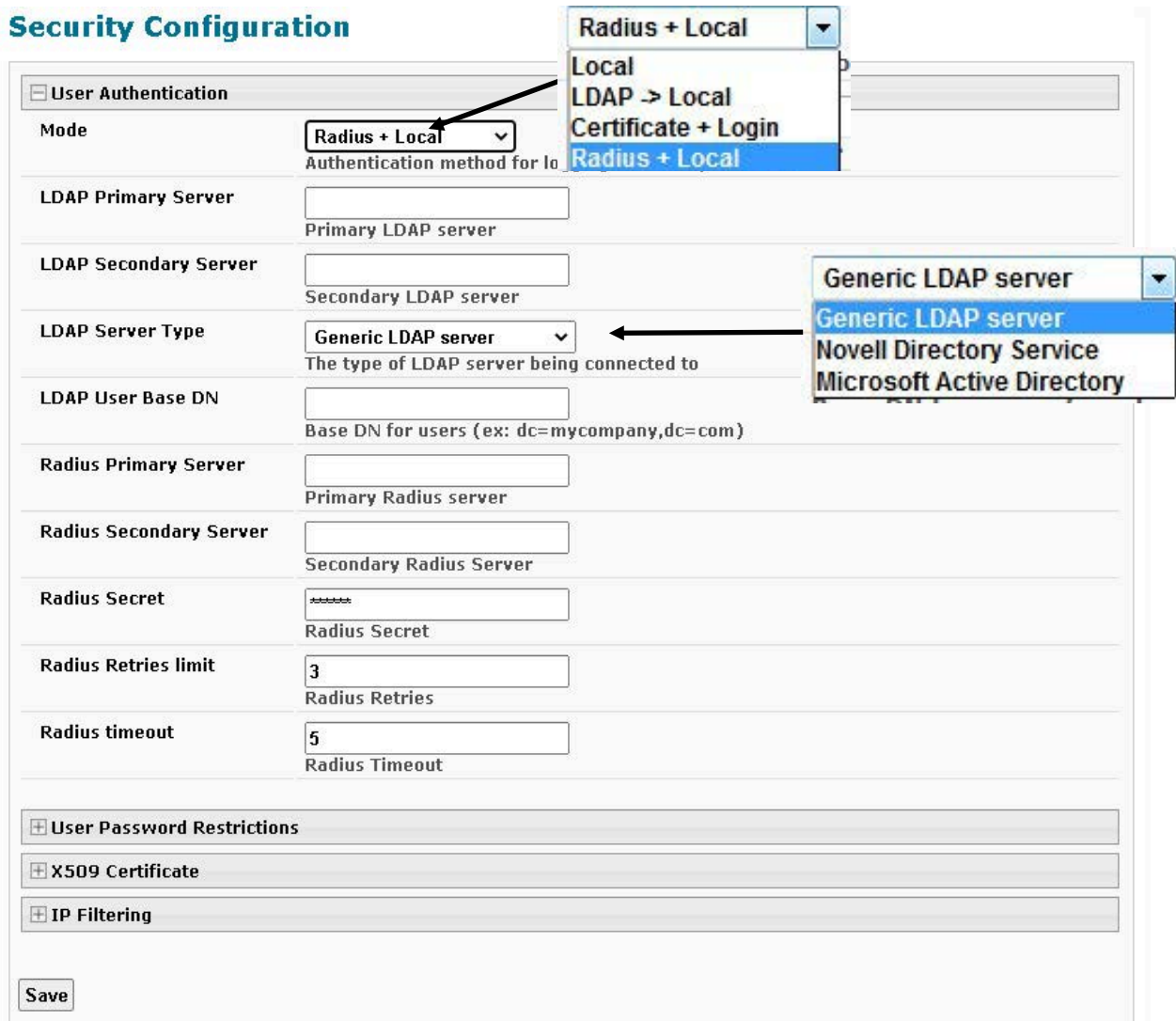

Figure 120- Security Configuration page

When in LDAP mode, usernames on the LDAP server **must match** those in the user settings of the ENVIROMUX or access will be denied.

Passwords for users can be different between the LDAP server and those in the ENVIROMUX configuration, so when in LDAP mode, make sure the LDAP password is the one being entered or access to the ENVIROMUX will be denied.

Note: When in LDAP mode, if the LDAP server is not responding, local authentication will be tried. If a mistake is made in the LDAP configuration and access to the ENVIROMUX is being denied, to return to local user setting control, disconnect the ENVIROMUX from the network and connect a PC to the ENVIROMUX ETHERNET port directly. Once the ENVIROMUX can no longer see the LDAP server the user will be able to login with a local account.

| User Authentication | |
|-------------------------|---|
| Mode | Select Local to use authentication based on passwords in the ENVIROMUX user configuration
Select LDAP->Local to use authentication based on passwords in an LDAP server
Select "Certificate+Login" when authentication requires the connecting PC to hold a valid certificate
Select "Radius +Local" to use either local user authentication or authentication through a RADIUS server |
| LDAP Primary Server | Enter Hostname or IP address of Primary LDAP Server |
| LDAP Secondary Server | Enter Hostname or IP address of Secondary LDAP Server (optional) |
| LDAP Server Type | Choose from drop down list:
Generic LDAP server
Novell Directory server
Microsoft Active Directory |
| LDAP User Base DN | Enter the Base DN for users (ex: ou=People,dc=mycompany,dc=com) |
| Radius Primary Server | Enter Hostname or IP address of Primary RADIUS Server |
| Radius Secondary Server | Enter Hostname or IP address of Secondary RADIUS Server (optional) |
| Radius Secret | Type the shared secret between the ENVIROMUX and the RADIUS server.
The shared secret is case-sensitive, and it must be the same on the ENVIROMUX and the RADIUS server. |
| Radius Retries Limit | The number of times the ENVIROMUX will try to submit the provided username and password to the RADIUS server before it reports a failed connection attempt |
| Radius Timeout | The length of time in seconds that the ENVIROMUX will wait for a reply from the RADIUS server before either reporting a failed connection attempt or resubmitting as determined by the Radius Retries Limit |

Even though LDAP authentication is being used, each user must also have a local account. User permission level is established by the local account.

When using an LDAP server, the ENVIROMUX is preloaded with a generic security certificate in X509 format. If you wish to provide your own X509 Server certificate, the Server certificate must be uploaded to the ENVIROMUX. See "[How to Create x509 Certificate](#)" for more information.

LDAP Server Troubleshooting

We recommend that you remain logged in to the ENVIROMUX as a local user on an administrative user's account while you test your LDAP server settings and verify that the LDAP server works correctly. If mistakes are made, as long as you are still logged in you can quickly make corrections. For example, using Chrome, make your changes to the LDAP server settings and press the **Save** button on the configuration page. Remain logged in and try logging in from another browser on the same PC (or from another PC altogether). If you can no longer get access to the ENVIROMUX (from the second browser/PC), you need to review and adjust your LDAP server settings and the settings in the ENVIROMUX (above and the user settings on page 94) until you find the cause.

In the event that you do log out before verifying your LDAP server settings are correct and now find your access to the ENVIROMUX is being denied, disconnect the ENVIROMUX from the network and connect a PC to the ENVIROMUX "ETHERNET" port directly. **By default, if the ENVIROMUX can not see the LDAP server the user will be able to login with a local ENVIROMUX account (provided the user's PC and the ENVIROMUX are both on the same subnet).**

If you don't know the IP address of the ENVIROMUX to make a direct local connection, you can either restore default settings or use the Discovery Tool (page 28) to identify the IP address assigned.

Using a RADIUS Server

The configuration has been tested using FreeRADIUS version 3 on Ubuntu 18.04.4 LTS.

Both HTTP and HTTPS requests have been tested.

1. The default directory for FreeRadius will be one of the following depending on your operating system:

- a. /etc/freeradius
- b. /etc/raddb

2. There are file path differences between FreeRADIUS version 2 and version 3. The **/etc/freeradius/3.0/mods-config/files/authorize** file should be modified in version 3 and the **/etc/freeradius/users** file should be modified in version 2.

Depending on the operating system, there may not be a 3.0 directory within the default FreeRADIUS directory and all files and folders within that directory are in the /etc/freeradius directory.

The *dictionary.nti* file (this file has an .nti extension) must be saved to a location on the PC the RADIUS server is run from. (This file is found on the ENVIROMUX download page (<http://www.networktechinc.com/download/d-environment-monitor-16.html>).)

3. Edit the RADIUS *dictionary* file (no file extension) in the RADIUS server using a text editor, adding the following line:

```
$INCLUDE /<path to dictionary.nti>/dictionary.nti
```

Example:

Open the file *dictionary* (no extension) found in the directory the RADIUS server is run from using a text editor

```

pre-defined dictionary files included with the server.
#
# Any new/changed attributes MUST be placed in this file, as
# the pre-defined dictionaries SHOULD NOT be edited.
#
# $Id$
#
#
# The filename given here should be an absolute path. |
#
$INCLUDE /etc/freeradius/dictionary.nti
$INCLUDE /usr/share/freeradius/dictionary
#
# Place additional attributes or $INCLUDEs here. They will
# over-ride the definitions in the pre-defined dictionaries.
#
    
```

(In this case the dictionary.nti file was saved to the directory /etc/freeradius)

Figure 121- Dictionary file of RADIUS server

Be sure to save the RADIUS *dictionary* file.

4. Once the *dictionary.nti* file has been included in the RADIUS server dictionary, users outlined in the RADIUS server *authorize* file (filename *authorize*, again, it has no extension) can be assigned these properties. This file is located in the **/etc/freeradius/3.0/mods-config/files/** directory. The values can be customized based on your requirements or kept the same for a group of users using a single variable. An example user configuration is below. Please note the tab characters preceding property names.

```

# Test Account
"Test"      Cleartext-Password := "T123est"
           Service-Type = Login-User,
           NTI-User-Permission := "readonly",
           NTI-User-Title := "Analyst",
           NTI-User-Department := "IT",
           NTI-User-Company := "VPI",
           NTI-User-Sensor-Groups := "1,3,4,5,6,7,8",
           NTI-User-Email := "network.technologies@gmail.com",
           NTI-User-Syslog-SNMP-Address := "192.168.3.10",
           NTI-User-Syslog-Facility := "2",
           NTI-User-SMS-Number := "1234567891",
           NTI-User-Enable-Email-Alert := 1,
    
```

To save time, you could copy and paste this list into your *authorize* file and then edit it as needed for your custom installation.

If you are still using FreeRADIUS version 2:
 The files: *dictionary*
 users
 dictionary.nti
all need to be in the same directory (in the example in Figure 118 that is /etc/freeradius/)

```

NTI-User-Enable-Brief-Email := 1,
  NTI-User-Enable-Syslog-Alert := 1,
  NTI-User-Enable-SNMP-Traps := 1,
  NTI-User-Enable-SMS-Alert := 0,
  NTI-User-Schedule-Type := "custom",
  NTI-User-Schedule-Start-Day := "sun",
  NTI-User-Schedule-End-Day := "sat",
  NTI-User-Schedule-Start-Hour := "01:00",
  NTI-User-Schedule-End-Hour := "22:00",
  NTI-User-SNMP-Auth-Protocol := "MD5",
  NTI-User-SNMP-Auth-Passphrase := "12345678",
  NTI-User-SNMP-Privacy-Protocol := "none",
  NTI-User-SNMP-Privacy-Passphrase := "123456789",
  NTI-User-SNMP-Traps-Version := "v3",
  NTI-User-Enable := 1

```

The above username is "Test", and the password is "T123est". All the properties listed mirror those found in the user configuration in the ENVIROMUX web interface. Change "Test" and "T123est" as needed for a user. For the "Enable" properties, "1," means yes and "0," means no.

5. Once the *dictionary* file is updated and users are added to the *authorize* file, please restart the RADIUS server service and correct syntax errors if any.

6. In order to use a RADIUS server to access the ENVIROMUX, the Mode must be changed to "Radius + Local" and the additional RADIUS fields (all under Security Configuration-User Authentication (page 102)) must first be entered. When finished, click the "Save" button. Changes will have immediate effect.

7. After this the ENVIROMUX will auto add/update RADIUS users and log them in (if successful). Local users accounts can also be used to login if added through the Web Interface. A maximum of 16 users are enabled and active at a time on a device. If more than 16 users login, ENVIROMUX will evict the least recently logged-in user.

Note: If the user password as configured in the RADIUS server is different than that set in the ENVIROMUX user account, the RADIUS server will adjust the ENVIROMUX user account password to match the one in the RADIUS server.

All radius property names are optional except for "NTI-User-Enable := 1". For a detailed list of available property values, please check *dictionary.nti* file.

Change User Attributes

To change user attributes on the RADIUS Server:

1. Edit the user's file in RADIUS (filename *users*, no extension) and make the desired changes to the user attributes.

ex. NTI-User-Permission := "admin"

2. Save the user file.

3. Restart the RADIUS service.

4. On the E-xD, delete the user that the changes have been made on in the RADIUS server.

5. Logout and Re-Login to the E-xD with the updated user's login and password.

The RADIUS server should automatically load the new user attributes into the E-xD unit.

Cisco ISE

Please follow the procedure to set Vendor Specific Attributes in Cisco ISE:

<https://www.cisco.com/c/en/us/support/docs/security/identity-services-engine/215525-use-radius-for-device-administration-wit.html>

E-xD devices require the following radius properties set as "Advanced Attributes Settings":

1. "NTI-User-Enable" set to 1
2. "NTI-User-Permission" set to "admin" or "operator" or "readonly"
3. NTI Vendor ID where required is 3699

Settings configured in *dictionary.nti* for FreeRADIUS can also be set on Cisco ISE.

X509 Certificate

The ENVIROMUX is designed to be configurable with secure access to the web interface controls. The ENVIROMUX is pre-loaded with a generic X509 Server Certificate. If you wish to provide your own X509 Server certificate, the Server certificate must be uploaded to the ENVIROMUX. The Server certificate and key must be combined in a single file ("PEM" format). For instruction to create your own certificate, see "[How to Create x509 Certificate](#)" for more information.

Browse to the Server certificate file and select it. Then load using the button "Upload Server Certificate and key".

Note: The key used should not be password protected.

User Password Restrictions

The screenshot shows a web interface titled "Security Configuration". Under the "User Authentication" section, the "User Password Restrictions" sub-section is expanded. It contains several settings, all of which are currently unchecked:

- Lower Case:** Require lower case letters in user password
- Upper Case:** Require upper case letters in user password
- Numbers:** Require numbers in user password
- Special Characters:** Require special characters in user password
- Min. Length:** Require minimum length of user password
- Set Min. Password Length:** A text input field contains the value "8", with the label "Set minimum length of user password" below it.

Below these settings are sections for "X509 Certificate" and "IP Filtering", both of which are collapsed. A "Save" button is located at the bottom left of the configuration area.

Figure 122- User Password Restrictions

Under Security Configuration there is the option to apply password restrictions to all user passwords, increasing the level of security making it that much more difficult to guess the password. Any new passwords that are set or changed will have the above restrictions. (Existing passwords created before these restrictions were set do not require updating.)

Any user with Admin level access (page 92) can change the password restrictions.

The usable "Special Characters" include: ! ~ @ # \$ % ^ & * () - _ + = { } [] | : ; " ' , . ? < >

X509 Certificate Authority

A Certificate Authority (CA) needs to be used to sign the server certificate describe above. This Certificate Authority can be created as a self-signed certificate in "CRT" format. It can also be given to you by an external Certificate Authority in "CRT" or "PEM" format.

For https to work properly, you must load the certificate of your CA onto the ENVIROMUX. Use the "**Browse**" button to browse to the file containing the CA certificate (which may also contain an intermediate certificate) and select it. Then click on the "**Upload CA certificate**" button. Please see "[How to Create x509 Certificate](#)" for more information.

The "**Restore default certificate**" button will restore the unit's default self-signed certificates if needed.

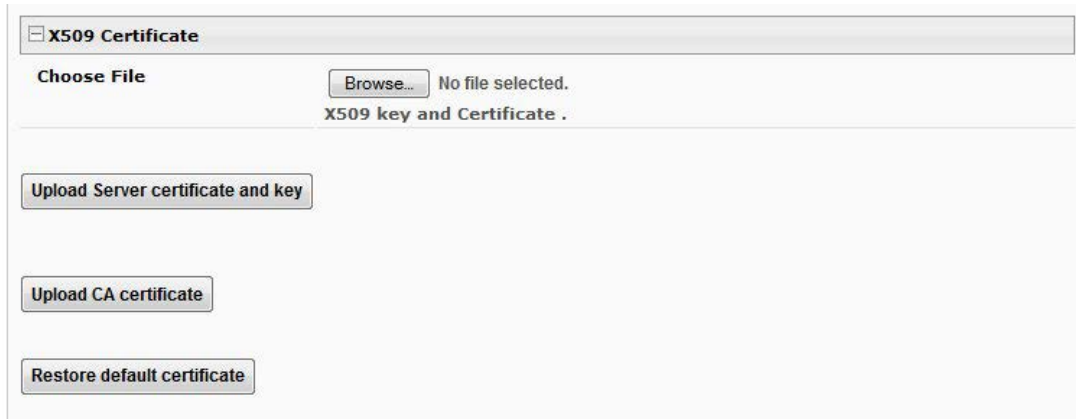

Figure 123- Security Configuration-X509 Certificate

Note: HTTP access can be enabled/disabled from web page under Administration -> Network -> Server Settings -> Enable HTTP (page 88). Do not disable http access until you verify certificate verification works properly for https connection. HTTP connection will allow you to change any settings if a wrong certificate is uploaded. Once HTTPS client certificate validation is verified to be working properly, disable HTTP access for security.

Resetting a bad Certificate uploaded without resetting other configuration and without access to http/https:

If invalid certificates or incorrectly formatted certificate files were uploaded to the E-xD, and the device is set to HTTPS only mode, that could cause no access to the webpages. To resolve this issue without resetting your device follow the steps.

1. Connect to the device using either SSH or Console/RS232 Port.
2. From Main menu navigate to 6. Security Configuration.
3. Select 3. Restore Default Certificate
4. A pop-up message will appear, select "Yes" to confirm restoring the X509 certificates to default and reboot the device. This should recover the device to get access to webserver page with default certificates

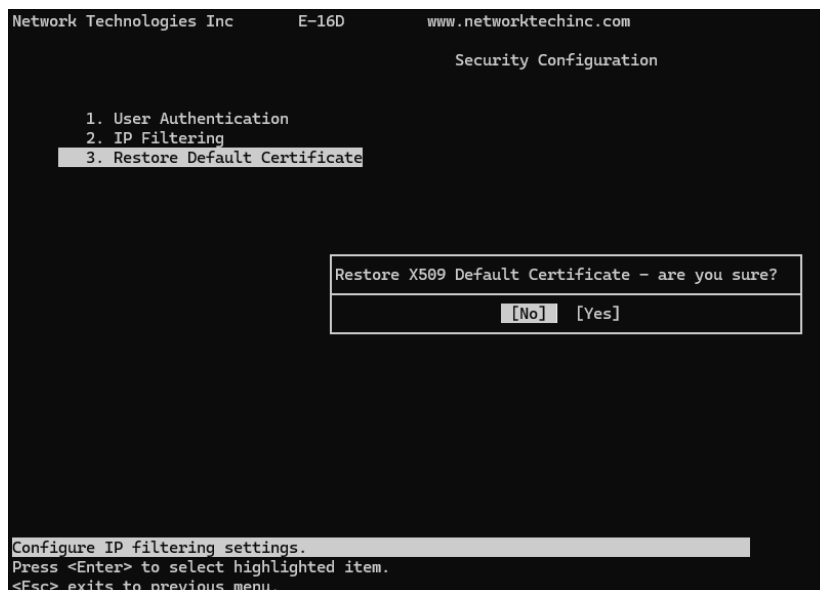

CLI Menu Restore Default Certificate

X509 Client Authentication

In addition to Local and LDAP client authentication, X509 client authentication is also available. In order to use X509 client certificate authentication, select **"Certificate + Login"** for the mode setting (Figure 120). X509 client certificate authentication requires the user to present client certification (this happens behind the scenes when you enter the https IP address, before you are presented with a "Login" screen). For this to work a client certificate signed by the same Certifying Authority (CA) used to sign the server certificate and key must be loaded into the user's browser (see ["How to Create x509 Certificate"](#) for more information).

Note: The user will need to login after the X509 client certificate is validated.

Whether you are just loading your own Server Certificate, or also using client authentication, **reboot the ENVIROMUX for this certificate to take effect.**

IP Filtering

Included in the Security Configuration options is IP Filtering. IP Filtering provides an additional mechanism for securing the ENVIROMUX. Access to the ENVIROMUX network services (SNMP, HTTP(S), SSH, Telnet) can be controlled by allowing or disallowing connections from various IP addresses, subnets, or networks.

Up to 16 IP Filtering rules can be defined to protect the ENVIROMUX from unwanted access from intruders. Each rule can be set as Enabled or Disabled. Rules can be set to explicitly drop attempts to connect, or to accept them.

Be sure to press **Save** after changes are made.

IP Filtering

| No. | Enabled | Mode | Filter Rule |
|-----|------------|--------|-----------------|
| 1 | Disabled ▾ | DROP ▾ | 192.168.0.0/32 |
| 2 | Disabled ▾ | DROP ▾ | 192.168.0.1/32 |
| 3 | Disabled ▾ | DROP ▾ | 192.168.0.2/32 |
| 4 | Disabled ▾ | DROP ▾ | 192.168.0.3/32 |
| 5 | Disabled ▾ | DROP ▾ | 192.168.4.0/24 |
| 6 | Disabled ▾ | DROP ▾ | 192.168.5.0/24 |
| 7 | Disabled ▾ | DROP ▾ | 192.168.6.0/24 |
| 8 | Disabled ▾ | DROP ▾ | 192.168.7.0/24 |
| 9 | Disabled ▾ | DROP ▾ | 192.168.8.0/24 |
| 10 | Disabled ▾ | DROP ▾ | 192.168.9.0/24 |
| 11 | Disabled ▾ | DROP ▾ | 192.168.10.0/24 |
| 12 | Disabled ▾ | DROP ▾ | 192.168.11.0/24 |
| 13 | Disabled ▾ | DROP ▾ | 192.168.12.0/24 |
| 14 | Disabled ▾ | DROP ▾ | 192.168.13.0/24 |
| 15 | Disabled ▾ | DROP ▾ | 192.168.14.0/24 |
| 16 | Disabled ▾ | DROP ▾ | 0.0.0.0/0 |

Note: Filter rules are processed from top to bottom. Ordering of rules is important since once a rule is matched, all remaining rules are ignored. Consult the product manual for more details.

Figure 124- Security Configuration- IP Filtering Rules

More on IP Filtering

The most common approach is to only allow “white-listed” IP addresses, subnets, or networks to access the device while blocking all others. The IP Filters are processed sequentially from top to bottom, so it is important to place the most precise rules at the top of the list and the most generic rules at the bottom of the list.

As an example, assume we wish to block all connections except those which come from the IP address 192.168.1.100. To allow connections from 192.168.1.100, we need to configure and enable an ACCEPT rule at the top of the list:

1 Enabled ACCEPT

Then, to block all other IP addresses from connecting to the ENVIROMUX, we add a rule to drop all other connections.

16 Enabled DROP

If the preceding “drop all connections” rule was placed in position one, no connections at all would be allowed to the unit. Remember: rules are processed from top to bottom. As soon as a rule matches, the processing stops and the matching rule is executed.

To match a particular IP address, simply enter in the desired IP address (e.g. 192.168.1.100).

To match a subnet, enter in the subnet with the associated mask (e.g. 192.168.1.0/24).

To match all IP address, specify a mask of 0 (e.g. 0.0.0.0/0).

System Information

The system information page displays the model name of the ENVIROMUX, the firmware version in the ENVIROMUX, the MAC address of the Ethernet port, the IP mode, and the network configuration. To view the System Information, select **System Information** in the **Administration** section of the main menu.

System Information

| System Information | |
|--------------------------|--|
| Product: | ENVIROMUX-16D Server Environment Monitoring System |
| Revision: | 2.79 |
| Build Date: | 06-11-2019 11:28:52 AM |
| MAC Address: | 00:0C:82:0F:01:E4 |
| Serial Number: | 16003 |
| IP Mode: | Static |
| IP Address: | 192.168.3.101 |
| Subnet Mask: | 255.255.255.0 |
| Default Gateway: | 192.168.3.3 |
| Primary DNS: | 192.168.1.52 |
| Secondary DNS: | 166.102.165.11 |
| SNMPv3 Engine ID: | 80001F8803000C820F01E4 |

IP address and gateway assigned to SIM card with 3G Data support

This number will be unique for each E-xD unit as the number includes the MAC address.

Figure 125- System Information page

Administration- Firmware

The Update Firmware page is used to change the firmware of the ENVIROMUX. Occasionally new features or changes to existing features will be introduced and new firmware with these changes will be made available on the NTI website (<http://www.networktechinc.com/download/d-environment-monitor-16.html>). To view the Update Firmware page, select **Firmware** in the **Administration** section of the main menu. Once a user has downloaded the required file for firmware upgrade, this page will be used to upload it to the ENVIROMUX.

Update Firmware

Caution! You have asked to update the firmware. Failure to update firmware properly can permanently damage the product.

Update file

Choose the firmware update file.
Current firmware version is 2.3.
Build Date: 02-19-2013 12:59:31 PM

Figure 126- Update Firmware Page

1. Download the most current firmware file from <http://www.networktechinc.com/download/d-environment-monitor-16.html> to a location on your PC.
2. Click on the "Browse" button and locate and select the firmware file for the ENVIROMUX (*enviromux-xd-vx-x.bin*, for example).
3. Click on the "Update" button to perform the firmware update. The firmware update process will take approximately 5 minutes while the ENVIROMUX installs the firmware. Once the update file has been installed, the unit will automatically reboot (this will take another 4-5 minutes after a firmware update) and the login screen will appear.

Note: In the event the ENVIROMUX firmware should be corrupted, such that connection through the web interface is no longer possible, contact NTI for instruction and recovery files to access the ENVIROMUX and restore the firmware using a TFTP server and Terminal connection (page 16).

Note: If "Use Secure Passwords Only" is enabled under Network Configuration -> Server Settings (see page 88), you will not be able to downgrade from firmware version 3.8 to an earlier firmware version. If you need to downgrade to an earlier firmware version, disable "Use Secure Password Only" first and then downgrade.

Reboot the System

The ENVIROMUX can be remotely rebooted by anyone with administrative privileges. To view the Reboot System page, select **Reboot** in the **Administration** section of the main menu. Click the **Reboot Now** button to cause the ENVIROMUX to reboot. This will disconnect any user and shut down all activity. Any configuration changes that were made prior to this action will be made active.

Reboot System

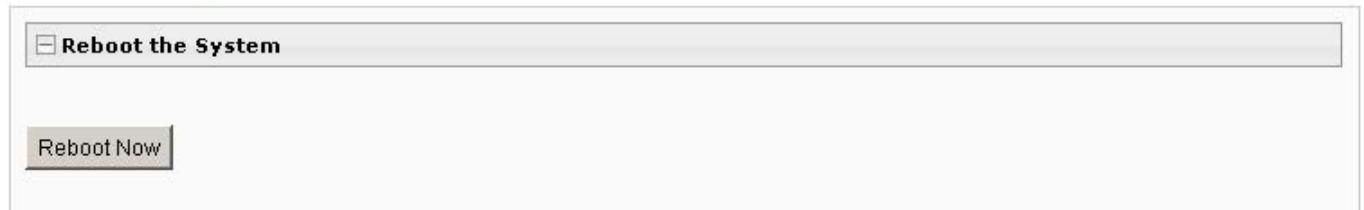

Figure 127- Reboot System page

The message "System is rebooting, please wait.... " will appear and after approximately 45-60 seconds the login screen will appear.

Log in to resume activity.

System Reboot

System is rebooting, please wait...

Figure 128- System is rebooting

Note: In the event of a power failure, using REBOOT will cause the ENVIROMUX to shut OFF.

Click on the "Reboot Now" button to shut down the ENVIROMUX in the event of a power failure or use the System Reset button on the front of the ENVIROMUX. During a power failure, this will be the only way the ENVIROMUX can be shut OFF. **The battery backup will power the ENVIROMUX for up to 1 hour.**

The power switch will only shut down the ENVIROMUX during normal operation. If the power switch is not shut OFF during a power failure, when AC power has been restored the ENVIROMUX will power ON automatically.

LOG

From the Log section there are three sub sections for configuring the ENVIROMUX:

| Log | | |
|--------------------|--------------------|---|
| View Event Log | View Event Log | View a log listing the date and time of events such as startups, shut downs, user logins |
| View Data Log | View Data Log | View data readings from sensors and IP addresses |
| View USB Data Log | View USB Data Log | View data readings that have been saved to a connected USB flash drive- Up to 1000 files will be displayed. |
| View USB Event Log | View USB Event Log | View Event Logs that have been saved to a USB flash drive- Up to 1000 files will be displayed. |
| View USB Images | View USB Images | View images that have been saved on a connected USB flash drive- A list of up to 1000 jpg images will be displayed |
| Log Settings | Log Settings | Configure how the logs are sent to users, how they handle reaching capacity, which users will be notified that it has reached capacity, and how they will be notified |

View Event Log

The Event Log provides the administrative user with a listing of many events (up to 1000 entries) that occur within the ENVIROMUX. The event log will record the date and time of:

- each ENVIROMUX startup,
- each user login and logout time,
- any time an unknown user tries to login,
- sensor and IP device alerts
- an alert handled by a user



Figure 129- Event Log page

From the Event Log page the administrative user can view the logs, select specific logs to be deleted or press **Clear Log** to delete them all. The number of entries per page can be changed for the user's reading preference. Navigating between pages is as easy as clicking **Previous** or **Next** buttons, or jumping to a specific page if you know where the log entry you are interested in is listed. The maximum size of the Data log is 1720 entries, the Event log maximum is 1000 entries, listed in chronological order.

To clear only specific log entries, place a checkmark in each line item to be deleted, and press **Delete Selected**. To select all entries at once, place a checkmark in the uppermost box. Before deleting, the user may want to save the log for future reference and to make space for more logs by downloading the event log to a file on a PC. Press **Download Event Log** to save the log file before clearing it.

To change the order in which the events are listed, the Sorting Order can be set to **Oldest First** or **Newest First**.

Example of an Event Log Message:

TIME: 07-27-2012 02:15:44 AM
 ENTERPRISE: E-16D Unit 1
 LOCATION: Engineering
 BRANCH: RACK: CONTACT: NTI
 DESCRIPTION: Temperature 1
 CONNECTOR: 1
 TYPE: Temperature
 MESSAGE: Sensor value crossed over non-critical thresholds
 VALUE: 85.0F

View Data Log

The Data Log provides the administrative user with a listing of all the readings taken by the ENVIROMUX pertaining to the sensors and IP Devices being monitored. The event log will record the date and time of each reading. The maximum size of each log is 1720 entries, listed in chronological order.

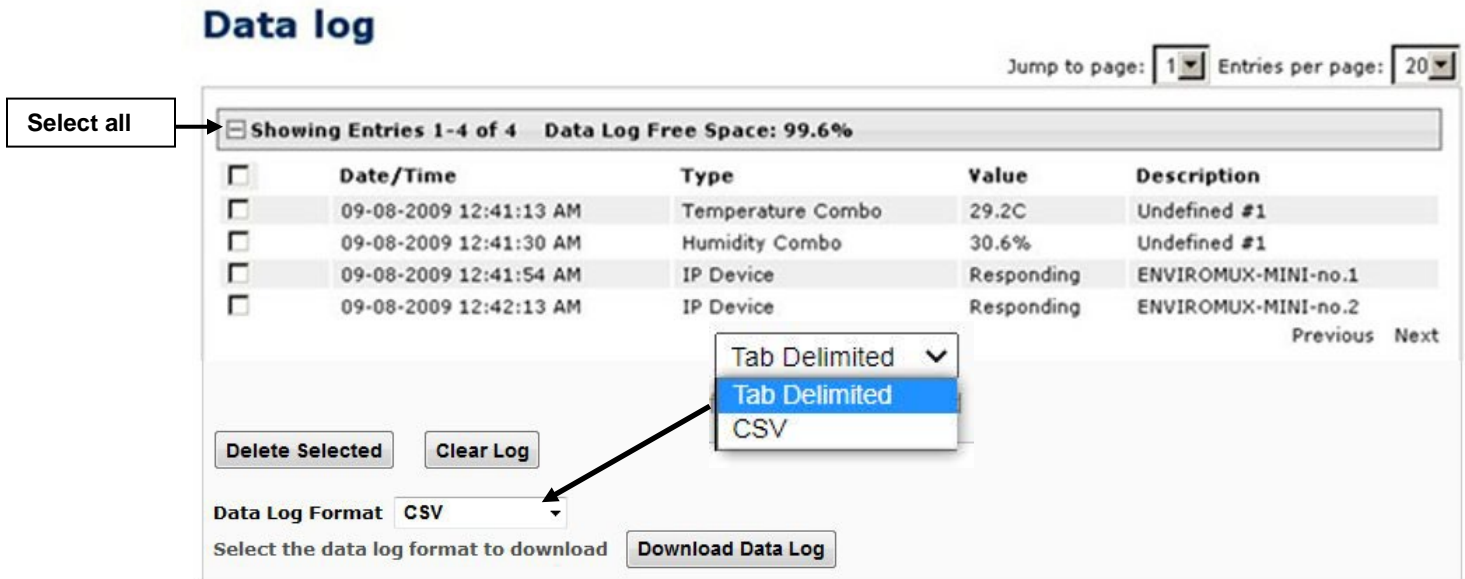

Figure 130- Data Log page

From the Data Log page the administrative user can view the logs, select specific logs to be deleted or press **Clear Log** to delete them all. The number of entries per page can be changed for the user's reading preference. Navigating between pages is as easy as clicking **Previous** or **Next** buttons, or jumping to a specific page if you know where the log entry you are interested in is listed.

To clear only specific log entries, place a checkmark in each line item to be deleted, and press **Delete Selected**. To select all entries at once, place a checkmark in the uppermost box. Before deleting, the user may want to save the log for future reference and to make space for more logs by downloading the event log to a file on a PC. Choose the **Data Log Format** (CSV or Tab Delimited), then press **Download Data Log** to save the log file before clearing it.

Example of a Data Log Message:

TIME: 07-27-2012 09:12:28 AM
 ENTERPRISE: E-16D Unit 1
 LOCATION: Engineering
 BRANCH: Bldg. B

RACK: IPMI
 DESCRIPTION: ACLMV 6 Main
 TIME:07-27-2012 09:12:28 AM
 TYPE: ACLM-V AC Voltage 1
 VALUE:115.5V

View USB Data Log

If any Data Logs have been saved to the USB flash drive connected to a USB port on the ENVIROMUX, a list of those logs can be viewed and opened for review.

The screenshot shows the 'USB data log' page in a web application. On the left is a navigation menu with categories: Monitoring, Administration, Smart Alerts, Log, and Support. The 'Log' category is expanded, showing options like 'View Event Log', 'View Data Log', 'View USB Data Log', 'View USB Images', and 'Log Settings'. The main content area is titled 'USB data log' and includes pagination controls (Jump to page: 1, Entries per page: 20) and a list of log files. The list shows two entries with checkboxes and file names. Below the list are buttons for 'Delete', 'Delete All', and 'Download USB Log Files'. The footer contains the text '© 2012, 2017 Network Technologies Inc. All rights reserved.' and a 'goahead WEBSERVER' logo.

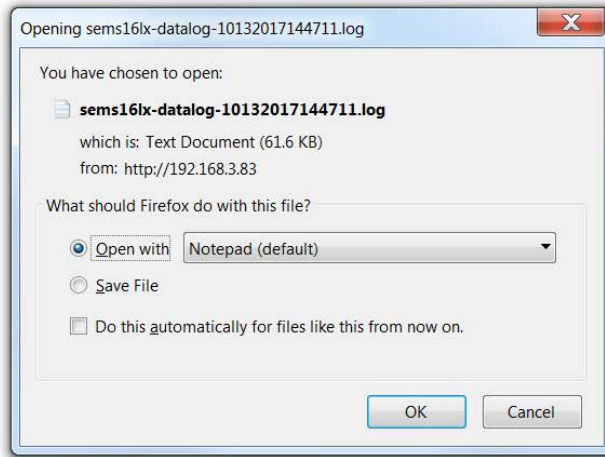

Figure 131- View Saved USB Data Log

View USB Event Log

If any Event Logs have been saved to the USB flash drive connected to a USB port on the ENVIROMUX, a list of those logs can be viewed and opened for review in the same fashion as the USB Data logs.

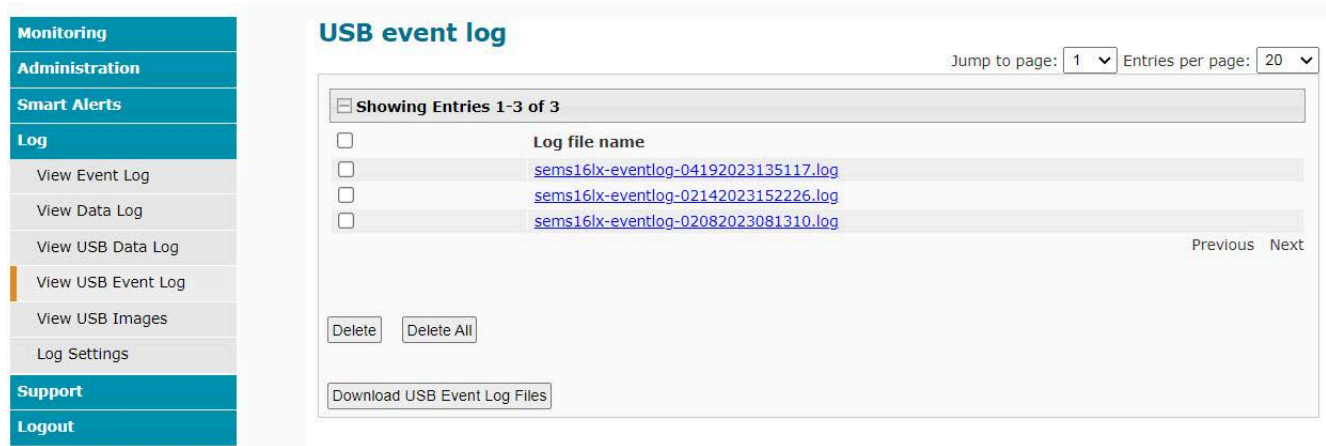

Figure 132- View Saved USB Event Log

View USB Images

If any IP camera images have been saved to the USB flash drive connected to the ENVIROMUX, a list of those images, up to 20 at a time, will be displayed. Click on an image to view it.

To delete specific images from the flash drive, place a checkmark in the box on the left side and click “Delete Selected”, or, to erase them all select “Delete All”.

To open more than one image sequentially or download them as a group, place a checkmark in several images and select “Download JPG Images”. You will be prompted to either open the images or download them to your PC.

USB images

Jump to page: 1 ▾ Entries per page: 20 ▾

Showing Entries 1-20 of 877

| <input type="checkbox"/> | JPG file name |
|--------------------------|---|
| <input type="checkbox"/> | 10132017135524Trendnet TV-IP662PI.jpg |
| <input type="checkbox"/> | 10132017135512Trendnet TV-IP662PI.jpg |
| <input type="checkbox"/> | 10132017135500Trendnet TV-IP662PI.jpg |
| <input type="checkbox"/> | 10132017135445Trendnet TV-IP662PI.jpg |
| <input type="checkbox"/> | 10132017135407Trendnet TV-IP662PI.jpg |
| <input type="checkbox"/> | 10132017135346Trendnet TV-IP662PI.jpg |
| <input type="checkbox"/> | 10132017135252Trendnet TV-IP662PI.jpg |
| <input type="checkbox"/> | 10132017135103Trendnet TV-IP662PI.jpg |
| <input type="checkbox"/> | 10132017135022Trendnet TV-IP662PI.jpg |
| <input type="checkbox"/> | 10132017134925Trendnet TV-IP662PI.jpg |
| <input type="checkbox"/> | 10132017134430Trendnet TV-IP662PI.jpg |
| <input type="checkbox"/> | 10132017134306Trendnet TV-IP662PI.jpg |
| <input type="checkbox"/> | 10132017134230Trendnet TV-IP662PI.jpg |
| <input type="checkbox"/> | 10132017134144Trendnet TV-IP662PI.jpg |
| <input type="checkbox"/> | 10132017134132Trendnet TV-IP662PI.jpg |
| <input type="checkbox"/> | 10132017133322Trendnet TV-IP662PI.jpg |
| <input type="checkbox"/> | 10132017133300Trendnet TV-IP662PI.jpg |
| <input type="checkbox"/> | 10132017133250Trendnet TV-IP662PI.jpg |
| <input type="checkbox"/> | 10132017133220Trendnet TV-IP662PI.jpg |
| <input type="checkbox"/> | 10132017133145Trendnet TV-IP662PI.jpg |

Previous [Next](#)

Figure 133- View Images saved on USB Flash Drive

Log Settings

The Log Settings page (Figure 134) provides settings for how the ENVIROMUX will react when its Data and Event logs reach capacity (1720 Data Logs, 1000 Event Logs).

Note: The E-16DEL will hold up to 1,200,000 Data Log entries and 3000 Event Log entries.

The Event Log settings include a Logging Level that can be configured to log different amounts of information:

- Error : shows only system errors (like sending e-mail failures or SMS)
- Alert: shows recorded system errors and alert messages
- Info: In addition to all of the above, the log will show less relevant information: user login/logout for example
- Debug: shows more frequent and detailed errors however the log will fill up much more rapidly

Log can be assigned to multiple groups and any user that receives messages from those groups can be notified when capacity is being reached. The log can be set to either:

- Discontinue- stop logging information
- Clear and restart- delete all log entries and restart with new entries
- Wrap- continue logging but delete the oldest entries so new ones can be recorded

Group selections under Event Log Settings decide which user groups receive notifications related to this E-xD device in general like device login failures, SMS failures, email failures, memory full etc

The Data and/or Event log can be set to send alerts to users via email, syslog, SMS and/or SNMP traps once it has reached 90% of capacity, allowing them time to react.

The Data log can also be set to send log entries via email, syslog, SMS and/or SNMP traps to users in addition to the entries it records internally. Enable Remote Logging for email, syslog, or SNMP as desired.

Data log entries can be sent individually or in bulk via email, and the start time of the bulk data log email can be controlled and selected.

1. Select "Send Bulk DataLog in Email". (Image right)
2. Select a "Bulk Email Delivery Start Time".
3. Select a time period for how often the email should be repeated ("Data Log Email Period").

For example, if the Data Log Email Period is set for 4 hours, then the log entries that were accumulated during each 4 hour period will be provided in the next bulk data log email.

Note: A bulk email will also be sent when the data log overflows (when it reaches 1724 entries).

Exception: If the data log is full, and the "Overflow Action" is set to discontinue logging, the bulk data log emails will also discontinue.

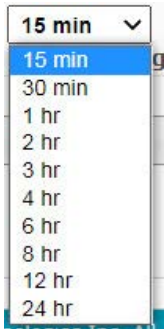

Data Log Email Period options

Note: The Bulk Email features are not available in the E-16DEL.

Log Settings

Event Log Settings

Logging Level: **Debug** (Select logging level)

Group #01: Sends non-sensor Alert notifications for Group 1

Group #02: Sends non-sensor Alert notifications for Group 2

Group #03: Sends non-sensor Alert notifications for Group 3

Group #04: Sends non-sensor Alert notifications for Group 4

Group #05: Sends non-sensor Alert notifications for Group 5

Group #06: Sends non-sensor Alert notifications for Group 6

Group #07: Sends non-sensor Alert notifications for Group 7

Group #08: Sends non-sensor Alert notifications for Group 8

Overflow Action: **Wrap** (Choose the action to take when the event log overflows)

Event Log Full Alert Settings

Enable Syslog Alerts: When event log reaches 90% of capacity, send alerts via syslog

Enable SNMP Traps: When event log reaches 90% of capacity, send alerts via SNMP traps

Enable E-mail Alerts: When event log reaches 90% of capacity, send alerts via e-mail

Enable SMS Alerts: When event log reaches 90% of capacity, send alerts via SMS

Data Log Settings

Group #01: Sends notifications for Group 1

Group #02: Sends notifications for Group 2

Group #03: Sends notifications for Group 3

Group #04: Sends notifications for Group 4

Group #05: Sends notifications for Group 5

Group #06: Sends notifications for Group 6

Group #07: Sends notifications for Group 7

Group #08: Sends notifications for Group 8

Overflow Action: **Wrap** (Choose the action to take when the data log overflows)

Enable Syslog Alerts: When data log reaches 90% of capacity, send alerts via syslog

Enable SNMP Traps: When data log reaches 90% of capacity, send alerts via SNMP traps

Enable E-mail Alerts: When data log reaches 90% of capacity, send alerts via e-mail

Enable SMS Alerts: When data log reaches 90% of capacity, send alerts via SMS

Enable Syslog Remote Logging: Send data log entries via Syslog messages

Enable SNMP Remote Logging: Send data log entries via SNMP Traps

Enable E-mail Remote Logging: Send data log entries via e-mail

E-mail Remote Logging Type: **Send Individual Entries in Email**

Bulk Email Delivery Start Time: **12 AM** (Set bulk data log email to start at)

Data Log Email Period: **24** (Bulk data log email frequency in hours)

Log To USB Flash Settings

Save

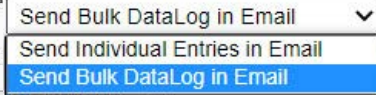
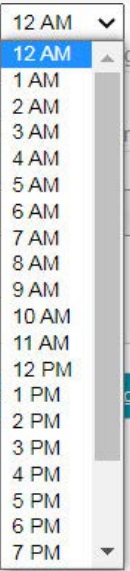

Figure 134- Log Settings page

Log to USB Flash Settings

Event and Data log messages are automatically sent to users as configured above in addition to being recorded in the logs. The logs can also be downloaded as a tab-delimited plain text file. If a USB flash drive is present (it doesn't matter which of the 4 ports it is plugged-into), logs will also be recorded on the flash drive to make them portable provided the feature is enabled.

The number of logs that can be recorded depends on the capacity of the flash drive installed. To begin recording to the flash drive, first connect a flash drive to an available USB port on the ENVIROMUX. Then change "Unmount" to "Mount" and click "Save". Then place a checkmark in the "Enable Log to Flash drive" box and click "Save" again.

The log can be saved in three different formats. Set it for space delimited, tab delimited or CSV (comma separated variables). Once the change is made, any future logs will be in the selected format.

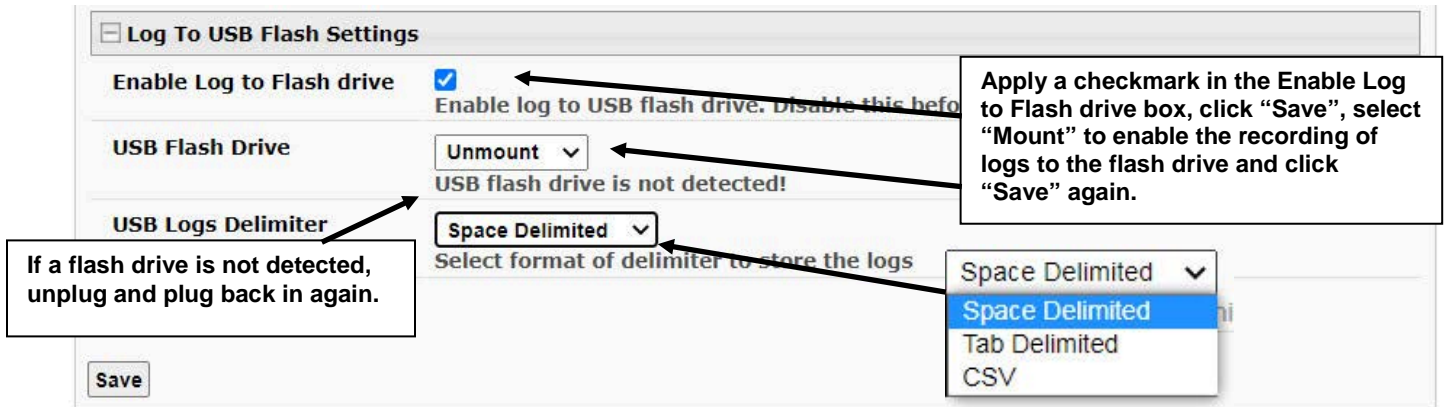

Figure 135- Mount a USB Flash Drive

Note: Only 1 flash drive can be connected to the ENVIROMUX at a time.

Note: If the "Overflow Action" under Data Log Settings is set to "Discontinue Log", then logging to the flash drive will also be stopped when the data log has reached capacity.

Note: The file system of the flash drive must be formatted FAT32 (not NTFS). Make sure there is plenty of space on it.

To remove a flash drive from the ENVIROMUX,

1. Uncheck "Enable Log to Flash drive" and click "Save",
2. Change "Mount" to "Unmount".
3. Click "Save" again. Now it is safe to remove the flash drive.



Figure 136- Steps to unmount a flashdrive

Support

The Support section of the menu includes two links, Manual and Downloads.

The Manual link will open the pdf manual for the ENVIROMUX on the NTI website. You must have Adobe Reader installed on your PC to open this.

The Downloads link will take you to the Firmware Downloads page for the ENVIROMUX on the NTI website. All versions of firmware and MIB files for the ENVIROMUX will be found there, available for immediate download to your PC.



Figure 137- Support

Logout

To logout of the ENVIROMUX user interface, click on the “Logout” section in the menu. A gray menu label will drop down. Click on the gray label to be immediately logged out. The login screen will appear, at which you can close your browser or log back in.

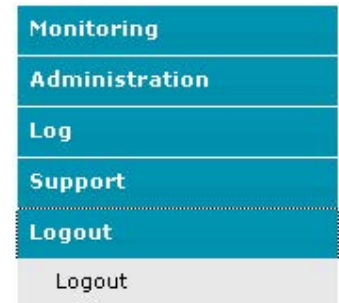

Figure 138- Logout

FRONT PANEL CONTROLS AND LED INDICATORS

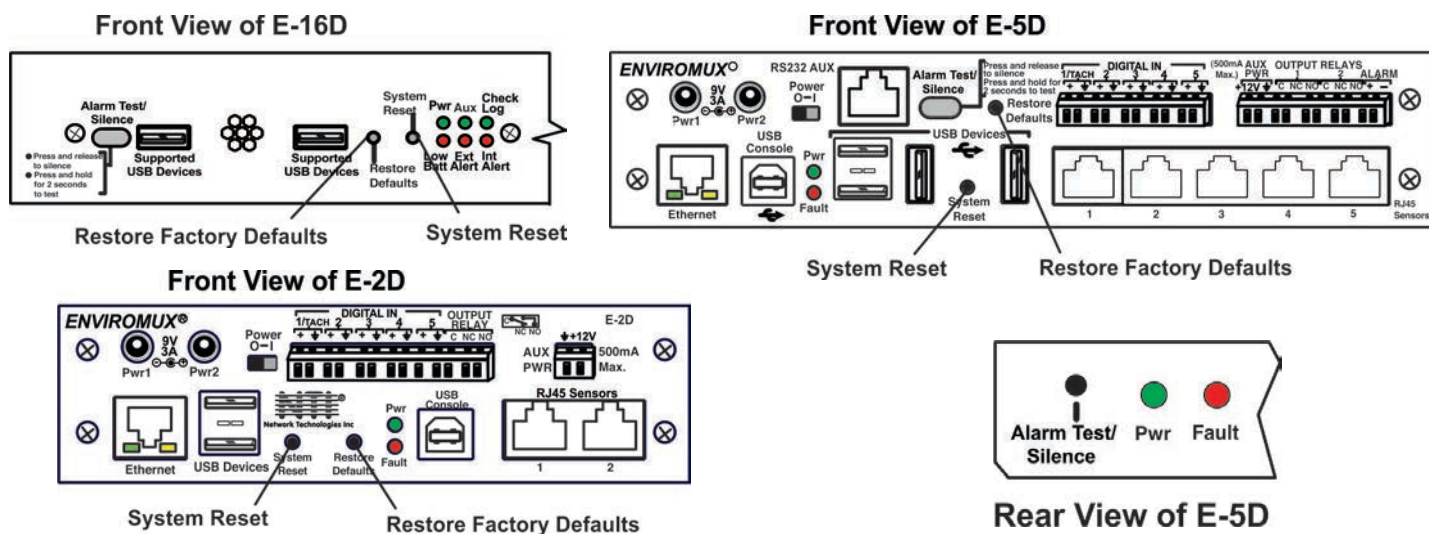

Figure 139- Front panel

Front Panel LED Status Chart

| LED Label | Status | Meaning |
|-----------|--------------------------------|--|
| Pwr | OFF | No Power |
| | Solid ON | AC Power is ON |
| | Blinking slowly (once /second) | AC Power has failed, Battery backup (pg. 121) is ON (The LED will not blink if the unit is powered OFF by the switch.) |
| Low Batt | Blinking rapidly | Discovery Tool (pg. 28) is in use and communicating with the ENVIROMUX |
| | | |
| Low Batt | OFF | Battery is OK, AC power is ON |
| | Solid ON | Battery is below 12V and charging (no action required) |
| | Blinking | Battery has been disconnected (battery is below 10.7V), requires attention, contact NTI |
| Check Log | OFF | No new messages in Data Log since last viewing |
| | ON | New message in Data Log-not an alert |
| Int Alert | OFF | No new alert message in Event Log re: internal sensors |
| | ON | New alert message in Event Log re: internal sensors |
| Ext Alert | OFF | No new alert message in Event Log re: external sensors |
| | ON | New alert message in Event Log re: external sensors |
| Fault | ON | A sensor has gone out of range of a configurable threshold |

Note: When power is first applied to the E-2D or -5D, both the Power LED (green) and Fault LED (red) will illuminate for the first 30 seconds of the boot process. After this the fault LED will turn OFF until a sensor alarm is generated which will turn the fault LED back ON.

System Reset Button

A reset button is located on the front of the ENVIROMUX (see Figure 139). The button can be used to reboot/restart the firmware of the ENVIROMUX. Pressing this button supersedes the use of the power on/off switch and battery backup to allow the firmware to easily reboot in the event of a system lockup. To activate a reset, momentarily press the button with a pen or other small pointed object. The ENVIROMUX will reboot and be ready for login within its usual start-up time period.

Alarm Test/Silence Button

A button is provided on the front of the E-16D and E-5D (and on the rear of the E-5D) to be used to test or to silence the alarm siren when an alarm siren is connected. To test the alarm function, press and hold the button for at least 2 seconds. The siren and beacon will "alarm" until the button is released. To silence an alarm, press and immediately release the button.

Restore Defaults Button

Another button is located on the front of the ENVIROMUX (see Figure 139). The button can be used to clear all configuration changes and restore the ENVIROMUX to default settings including the administrative password. To use this button, press it with a pen or other small pointed object and hold it for 5 seconds. The ENVIROMUX will reboot and be ready for login within its usual start-up time period. If possible, consider saving the ENVIROMUX configuration before using this button (page 73).

BATTERY BACKUP

E-16D

E-16D has a rechargeable sealed lead-acid battery backup that will prevent the monitoring system from shutting down in the event of a power failure. Should a service power failure occur, **the ENVIROMUX will continue to operate as normal for 1 hour under full load** and approximately 30 minutes after the "Low Batt" LED on the front panel (page 53) illuminates.

When the battery is not being used, it is being charged as long as line power is provided. It will take 24 hours for the battery to fully charge from a fully discharged state. While charging the "Low Batt" LED will be solid ON.

If the power is ON and the battery is fully charged, the "Low Batt" LED will be dark.

If the battery fails to charge or if the battery's output voltage drops from 12VDC to below 10.7 volts, the "Low Batt" LED will blink. The battery will automatically be disconnected from the system. If this happens, the battery must be replaced. Contact NTI to purchase a battery and refer to the [ENVIROMUX Battery Replacement](#) instructions.

Note: While operating the E-16D using the battery backup, to shut OFF the ENVIROMUX, switch the power switch to OFF and press the System Reset button.



CAUTION

RISK OF ELECTRIC SHOCK. We recommend you remove mains power if the cover is removed to replace a battery. Exercise extreme caution to prevent contact with mains power.

E-5DB / -2DB

E-5DB /-2DB has a rechargeable lithium-ion battery backup that will prevent the monitoring system from shutting down in the event of a power failure. Should a service power failure occur, **the ENVIROMUX will continue to operate as normal for 2 hours under full load.**

When the battery is not being used, it is being charged as long as line power is provided. It will take 24 hours for the battery to fully charge from a fully discharged state. If the battery fails to provide power during a power failure after allowing ample charge time, contact NTI to purchase a battery and refer to the [ENVIROMUX Battery Replacement](#) instructions.



CAUTION

RISK OF ELECTRIC SHOCK. We recommend you remove mains power if the cover is removed to replace a battery. Exercise extreme caution to prevent contact with mains power.

USB PORT

The ENVIROMUX are each equipped with USB Type A female ports on the front and rear panel for connection of a USB flash drive, a GSM modem or for receiving alert messages via SMS.

- The ports are compatible with USB 2.0 Full Speed flash drives. When enabled (page 118) and with the USB flash drive connected, the Event and Data Logs will be written to a text file on the flash drive in addition to the memory in the ENVIROMUX.
- When a modem is connected (page 18), it will automatically be sensed by the ENVIROMUX (page 77).



Figure 140- USB Flash Drive/Modem/LCD Monitor port

To enable recording logs to a flash drive,

1. Connect a FAT32 formatted flash drive to an available USB port on the ENVIROMUX. Make sure there is plenty of space on it.
2. Apply a checkmark to the check box “Enable Log to Flash Drive”, click “Save”, change “Unmount” to “Mount” and click “Save” again on the Log Settings page (page 118).

While the flash drive is present, the Event and Data Logs will be written to a text file on the flash drive in addition to the memory in the ENVIROMUX.

Note: When using the USB port with a flash drive, be sure to remove the checkmark from the “Enable Log to Flash Drive”, click “Save”, change “Mount” to “Unmount” and click “Save” again in the Log Settings page (page 118) before removing the flash drive from the port. Failure to do so may result in a loss of data stored on the drive.

Note: Only 1 flash drive can be connected to the ENVIROMUX at a time. Additional drives will be ignored.

Note: The file system of the flash drive must be formatted FAT32 (not NTFS).

SERIAL CONTROL

The ENVIROMUX can be controlled serially through a text menu using one of these methods:

- a terminal program (e.g. HyperTerminal) from a PC connected to the RJ45 “RS232” port (page 16),
- a terminal program from a PC connected to the USB “Console” Port (page 16),
- Telnet protocol using an Ethernet connection (page 17),
- SSH protocol using an Ethernet connection (page 17).

Either of these methods will work to access the ENVIROMUX text menu. The text menu can be used to control most functions of the ENVIROMUX as an alternative to the Web Interface (page 29). For more on using the text menu, see the [Serial Control Manual](#).

MOBILE SUMMARY PAGE

The user can login to the ENVIROMUX through the browser on a smart phone or similar device to view a Summary Page for the sensor status (below). To login, type the current IP address of the ENVIROMUX into the address bar of the browser (default IP address used in the example below):

`http://192.168.1.21/`

Note: The ENVIROMUX must have a public accessible IP address for this to work or your browsing device must be connected to the same local network as the ENVIROMUX.

Note: If the HTTP Server Port number is changed (page 88) from port 80 (default), then the port number will need to be added to the IP address (i.e. if the port number is changed to 95, then the IP address would be `http://192.168.1.21:95`)

A log in prompt requiring a username and password will appear:

Username = root

Password = nti

(lower case letters only)

Note: usernames and passwords are case sensitive

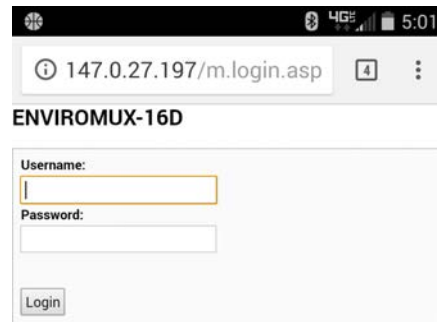

Figure 141- Mobile Login page

With a successful login, a screen similar to the following will appear. This is the only information that can be accessed through the interface. Select **“Refresh”** to refresh the information on the display. Select **“Log out”** when you are finished viewing the information. For access to the complete web interface, select **“Full Version”**.

Note: The display will refresh automatically every 15 seconds

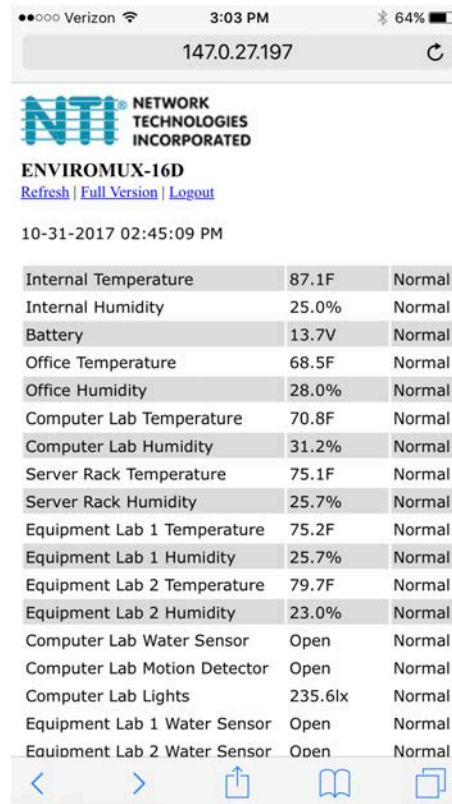

Figure 142- Mobile Summary page

E-16D SPECIFICATIONS

Front Panel Interface

| | |
|--------------|--|
| LEDs | Green – Power, Solid for Main power, flashing for Backup power |
| | Red – Low Bat (solid for charging battery, blinking for fault) |
| | Green – Check Log |
| | Green – AUX (not used) |
| | Red – Internal Sensor Alert |
| | Red – External Sensor Alert |
| USB..... | USB Type A Female X2, USB 2.0 Full Speed compatible |
| Buttons..... | Alarm Test/Silence- momentary switch |
| | Restore Defaults- momentary switch |
| | System Reset- momentary switch |

RJ45 Sensor Inputs

| | |
|------------------------|--|
| Connector | RJ45 connector |
| Voltage Supply..... | 5VDC and 12VDC |
| Signal Type..... | RS485 for RS485 sensors; 2-wire for contact sensors |
| Max. Cable Length..... | 1000 FT |
| ESD Protection | IEC 61000-4-2 |
| Fuse Protection..... | 12V Resetable poly fuse – 500mA hold, 1A trip; 15VDC max. One fuse shared by ports 1-8, another fuse shared by ports 9-16. . |
| | 5V Resetable poly fuse - 750mA hold, 1.5A trip; 16VDC max. One fuse shared by all 16 ports |

Digital Inputs

| | |
|--------------------------------|---|
| Connector | Detachable terminal block-plug-in, 8 x 4 contacts |
| Wire Range..... | 16-26 AWG |
| Max. Input Voltage..... | 25VDC |
| Max. Contact Resistance..... | 1K Ohm |
| Auxiliary Voltage Supply | 12VDC+/-10% |
| Max. Current Supply | 50 mA (terminals 1-7) 350mA (terminal 8 <u>only</u>) |
| ESD Protection | IEC 61000-4-2 |
| Fuse Protection..... | Resetable poly fuse – 200mA hold, 400mA trip; 16VDC max. One fuse shared by 2 ports |

Output Relays

| | |
|-------------------------|---|
| Connector | Detachable terminal block-plug-in, 4 x 3 contacts |
| Wire Range..... | 16-26 AWG |
| Output Type..... | Dry contact, relay isolated |
| Output Rating..... | 1A / 30 VDC, 0.5A / 100VAC |
| Contact Resistance..... | 20 milliohm |
| ESD Protection | No, Relay Isolated. |
| Fuse Protection..... | Non-resetable, 2A Hold, 4A trip, 125V |

Warning: The digital output relay contacts are not to be connected directly to AC mains wiring.

Beacon Port & Siren Port

| | |
|----------------------|--|
| Connector | Detachable terminal block-plug-in, 1x2 contacts |
| Wire Range..... | 16-26 AWG |
| Voltage Output..... | 12VDC+/-10% |
| Current Output..... | 180mA |
| ESD Protection | IEC 61000-4-2, |
| Fuse Protection..... | Resetable poly fuse – 200mA hold, 400mA trip; 16VDC max. |

USB Device Ports

Connector.....USB Type A Female
Version.....USB 2.0 Full Speed compatible

Control Serial Port “RS232”

ConnectorRJ45 Female
Supported SignalsTXD, RXD, RTS, CTS, DTR, DSR
Baud Rate.....max 115,200 bps
Data Format.....8 bits
Parity.....odd, even or no parity
Stop Bits1, 2 stop bits
ESD ProtectionIEC1000-4-2

USB-Serial Port “Console”

ConnectorUSB Type B Female
Supported SignalsD+ ,D-
Baud Rate.....max 115,200 bps
Data Format.....8 bits
Parity.....no parity
Stop Bits1 stop bits
ESD ProtectionIEC1000-4-2

Auxiliary Power Port

ConnectorDetachable terminal block-plug-in, 1x2 contacts
Wire Range.....16-26 AWG
Voltage Output.....12VDC+/-10%
Current Output.....150mA
ESD ProtectionIEC 61000-4-2
Fuse Protection.....Resetable poly fuse – 200mA hold, 400mA trip; 30VDC max.

Ethernet Port

ConnectorRJ45 Female
Connection Speed10/100 Base-T
Security.....TLS
Supported Protocolshttp, https, Telnet,SSH

Back-Up Battery

Type.....Rechargeable Sealed Lead-Acid Battery
Voltage, Current Rating12VDC, 2.9Ahrs
Battery Operational Time.....1 hr, fully loaded; 30 min. after ‘Low Bat’ LED illuminates
Battery Charging Time.....32 hrs (from fully discharged to fully charged).
Replaceable.....Yes – can be replaced by authorized personnel only (NTI)

General Specifications

Power Input.....110/220VAC, 50 – 60 Hz, 45W
Operating Temperature.....32° -104°F (0-40°C)
Operating Humidity5-90%RH, non-condensing
MTBF39,685 hours
Enclosure Size(WxDxH)1 RU metal enclosure (19 x 9.5 x 1.73 inches)

TCP/IP

Supported BrowsersIE, Netscape, Mozilla, Opera,Chrome
Network ConfigurationAllows Static or Dynamic IP Configuration
Max Number of Email Addresses17; 1 per User Account + 1 for Administrator

E-5D SPECIFICATIONS

User Interface

LEDs Green – Power (solid when ENVIROMUX is powered ON)
 Red – Fault (solid when any sensor is in alert)

RJ45 Sensor Inputs

Connector RJ45 connector
 Voltage Supply..... 5VDC and 12VDC
 Signal Type..... RS485 for RS485 sensors; 2-wire for contact sensors
 Max. Cable Length..... 1000 FT
 ESD Protection IEC 61000-4-2
 Fuse Protection..... Resettable poly fuse – 500mA x2 - shared for 5VDC and shared for 12VDC

Digital Inputs

Connector Detachable terminal block-plug-in, 5 x 2 contacts
 Wire Range..... 16-26 AWG
 Max. Input Voltage..... 25VDC
 Max. Contact Resistance..... 300K ohm
 ESD Protection IEC 61000-4-2

Output Relays

Connector Detachable terminal block-plug-in, 2 x 3 contacts
 Wire Range..... 16-26 AWG
 Output Type..... Dry contact, relay isolated
 Output Rating..... 1A / 30 VDC, 0.5A / 100VAC
 Contact Resistance..... 20 milliohm
 ESD Protection No, Relay Isolated.
 Fuse Protection..... Non-resettable, 2A Hold, 4A trip, 125V

Warning: The digital output relay contacts are not to be connected directly to AC mains wiring.

Alarm Port

Connector Detachable terminal block-plug-in, 1x2 contacts
 Wire Range..... 16-26 AWG
 Voltage Output..... 12VDC+/-10%
 Current Output..... 180mA
 ESD Protection IEC 61000-4-2,
 Fuse Protection..... Resettable poly fuse – 200mA hold, 400mA trip; 16VDC max.

USB Device Ports

Connector..... USB Type A Female
 Version..... USB 2.0 Full Speed compatible

USB-Serial Port “Console”

Connector USB Type B Female
 Supported Signals D+ ,D-
 Baud Rate max 115,200 bps
 Data Format 8 bits
 Parity no parity
 Stop Bits 1 stop bits
 ESD Protection IEC1000-4-2

Auxiliary Power Port

Connector Detachable terminal block-plug-in, 1x2 contacts
 Wire Range 14-22 AWG
 Voltage Output 12VDC +/-10%
 Current Output 500mA
 ESD Protection IEC 61000-4-2
 Fuse Protection Resetable poly fuse – 1.1A hold, 1.95A trip; 16VDC max.

Ethernet Port

Connector RJ45 Female
 Connection Speed 10/100 Base-T
 Security TLS
 Supported Protocols http, https, Telnet,SSH

General Specifications

Power Input 120VAC or 240VAC at 50 or 60Hz-9VDC/3A AC Adapter
 Operating Voltage 9-12VDC
 Operating Temperature 32° -140°F (0-60°C) / (-5DB model) 32° -104°F (0-40°C)
 Operating Humidity 5-90%RH, non-condensing
 MTBF 170,344 / (-5DB model) 169,279 hours

| Part Number | Dimensions |
|--------------|---------------------------------|
| E-5D(-D) | 7.88x3x1.75 in (200x76x44 mm) |
| E-5DB(-D) | 7.88x3x1.75 in (200x76x44 mm) |
| E-5D-48V(LT) | 10.6x3.1x1.75 in (269x79x44 mm) |
| E-5D-IND(LT) | 7.88x3x1.75 in (200x76x44 mm) |
| E-5DB-IND | 10.6x3.1x1.75 in (269x79x44 mm) |

TCP/IP

Supported Browsers IE, Netscape, Mozilla, Opera,Chrome
 Network Configuration Allows Static or Dynamic IP Configuration
 Max Number of Email Addresses 17; 1 per User Account + 1 for Administrator

Optional Battery

Type Lithium-ion-rechargeable
 Rated Capacity 2400mAh
 Maximum current2A
 Output 7.4VDC
 Duration 2 Hrs Minimum

E-2D SPECIFICATIONS

User Interface

LEDs Green – Power (solid when ENVIROMUX is powered ON)
 Red – Fault (solid when any sensor is in alert)

RJ45 Sensor Inputs

Connector RJ45 connector (2)
 Voltage Supply..... 5VDC and 12VDC
 Signal Type..... RS485 for RS485 sensors; 2-wire for contact sensors
 Max. Cable Length..... 1000 FT
 ESD Protection IEC 61000-4-2
 Fuse Protection..... Resettable poly fuse – 200mA x2 - shared for 5VDC and shared for 12VDC

Digital Inputs

Connector Detachable terminal block-plug-in, 5 x 2 contacts
 Wire Range..... 16-26 AWG
 Max. Input Voltage 25VDC
 Max. Contact Resistance 300K ohm
 ESD Protection IEC 61000-4-2

Output Relays

Connector Detachable terminal block-plug-in, 3 contacts
 Wire Range..... 16-26 AWG
 Output Type Dry contact, relay isolated
 Output Rating..... 1A at 125VAC or 30VDC
 Contact Resistance..... 20 milliohm
 ESD Protection No, Relay Isolated.
 Fuse Protection..... Non-resettable, 2A Hold, 4A trip, 125V

Warning: The digital output relay contacts are not to be connected directly to AC mains wiring.

USB Device Ports

Connector..... USB Type A Female
 Version..... USB 2.0 Full Speed compatible

USB-Serial Port “Console”

Connector USB Type B Female
 Supported Signals D+ ,D-
 Baud Rate..... max 115,200 bps
 Data Format..... 8 bits
 Parity..... no parity
 Stop Bits 1 stop bits
 ESD Protection IEC1000-4-2

Auxiliary Power Port

Connector Detachable terminal block-plug-in, 1x2 contacts
 Wire Range 16-26 AWG
 Voltage Output 12VDC+/-10%
 Current Output 500mA
 ESD Protection IEC 61000-4-2
 Fuse Protection Resettable poly fuse – 1.1A hold, 1.95A trip; 16VDC max.

Ethernet Port

Connector RJ45 Female
 Connection Speed 10/100 Base-T
 Security TLS
 Supported Protocols http, https, Telnet,SSH

General Specifications

Power Input 120VAC or 240VAC at 50 or 60Hz-9VDC/3A AC Adapter
 Operating Voltage 9-12VDC
 Operating Temperature 32° -140°F (0-60°C)
 Operating Humidity 5-90%RH, non-condensing
 MTBF 229,580 / (-2DB model) 230,693 hours

| Part Number | Dimensions | Comments |
|-------------|---------------------------------|-----------------------------|
| E-2D | 5.82x3x1.75 in (148x76x44 mm) | |
| E-2DB | 5.82x3x1.75 in (148x76x44 mm) | |
| E-2D-D | 5.82x3.3x1.75 in (148x84x44 mm) | Included DIN mount in Depth |
| E-2DB-D | 5.82x3.3x1.75 in (148x84x44 mm) | Included DIN mount in Depth |
| E-2D-24V | 10.6x3.1x1.75 in (270x79x44 mm) | |
| E-2D-48V | 10.6x3.1x1.75 in (270x79x44 mm) | |
| E-2D-IND | 5.82x3x1.75 in (148x76x44 mm) | |
| E-2D-POE | 5.82x3x1.75 in (148x76x44 mm) | |

TCP/IP

Supported Browsers IE, Netscape, Mozilla, Opera, Chrome
 Network Configuration Allows Static or Dynamic IP Configuration
 Max Number of Email Addresses 17; 1 per User Account + 1 for Administrator

Optional Battery

Type Lithium-ion-rechargeable
 Rated Capacity 2400mAh
 Maximum current2A
 Output 7.4VDC
 Duration 2 Hrs Minimum

PORT ASSIGNMENTS

Here are the default ports used by the ENVIROMUX:

- 80 HTTP
- 443 HTTPS
- 22 SSH
- 23 Telnet
- 161 SNMP (machine configuration & sensor data)
- 162 SNMP (traps)
- 502 MODBUS (default port)
- 514 SYSLOG
- 5908 Sensor info for the Management Software
- 5919 Cascading via Ethernet
- 6000 Management Software

The HTTP, HTTPS and MODBUS port numbers may be changed by the administrator. If they are changed, contact the system administrator for the new assignments.

DDNS PROVIDER LIST

| DDNS Provider | Provider Name To Use | DDNS Provider | Provider Name To Use |
|--------------------|----------------------|--------------------|----------------------|
| Changelp | changeip | gira.de | gira |
| OVH | ovh | sitelutions.com | sitelutions |
| Strato | strato | dnsomatic.com | dnsomatic |
| cloudxns | cloudxns | dynsip.org | dynsip |
| ddnss.de | ddnss.de | no-ip.com | no-ip |
| dhis | dhis | 3322.org | 3322 |
| dnsexit | dnsexit | he.net | he |
| dtdns | dtdns | spdyn.de | spdyn |
| duckdns | duckdns | nsupdate.info | nsupdate |
| duiadns | duiadns | loopia.com | loopia |
| dyndns.org | dyndns | domains.google.com | domains.google |
| dynv6.com | dynv6 | tzo.com | tzo |
| easydns.com | easydns | zerigo.com | zerigo |
| freedns.afraid.org | freedns | zoneedit.com | zoneedit |
| freemyip.com | freemyip | | |

WIRING METHODS

RS485 Sensor Cable

The CAT5 connection cable between the ENVIROMUX and the external RS485 Sensors (page 11) is terminated with RJ45 connectors and must be wired according to the EIA/TIA 568 B industry standard. Wiring is as per the table and drawing below.

| Pin | Wire Color | Pair |
|-----|--------------|------|
| 1 | White/Orange | 2 |
| 2 | Orange | 2 |
| 3 | White/Green | 3 |
| 4 | Blue | 1 |
| 5 | White/Blue | 1 |
| 6 | Green | 3 |
| 7 | White/Brown | 4 |
| 8 | Brown | 4 |

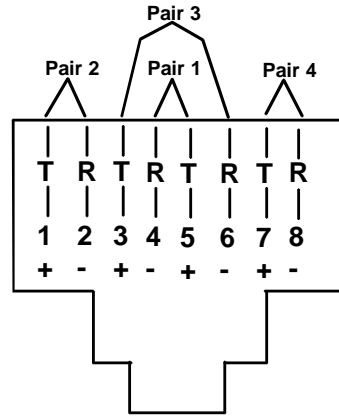

(View Looking into RJ45 Socket)

Contact Sensor Wiring

When applying CAT5 cables to contact sensors for plug-in to the RJ45 Sensor sockets, the following socket-to-sensor wiring must be followed:

RJ45 Sensor Socket Pinout

| Pin # | Pin Name |
|-------|---------------|
| 1 | GND |
| 2 | SENSE |
| 3 | RS485 + |
| 4 | +5 VDC |
| 5 | TAMPER SWITCH |
| 6 | RS485 - |
| 7 | +12 VDC |
| 8 | GND |

Schematic for wiring Contact Sensor to RJ45 Socket

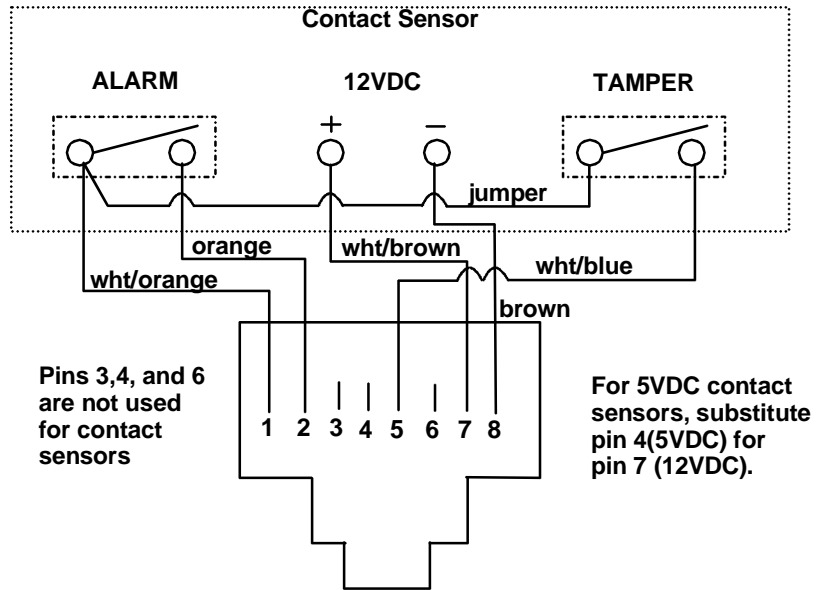

Pins 3,4, and 6 are not used for contact sensors

For 5VDC contact sensors, substitute pin 4(5VDC) for pin 7 (12VDC).

View looking into RJ45 Socket

TROUBLESHOOTING

Each and every piece of every product produced by Network Technologies Inc is 100% tested to exacting specifications. We make every effort to insure trouble-free installation and operation of our products. If problems are experienced while installing this product, please look over the troubleshooting chart below to see if perhaps we can answer any questions that arise. If the answer is not found in the chart, a solution may be found in the knowledgebase on our website at <http://information.networktechinc.com/jive/kbindex.jspa> or please call us directly at (800) 742-8324 (800-RGB-TECH) or (330) 562-7070 and we will be happy to assist in any way we can.

| Problem | Cause | Solution |
|---|---|---|
| “Pwr” LED is blinking (E-16D only) | <ul style="list-style-type: none"> Blinking 1/sec =Power is OFF, battery backup is powering the ENVIROMUX Blinking rapidly= discovery tool in use | <ul style="list-style-type: none"> Restore AC power to the ENVIROMUX Nothing wrong- close Discovery Tool to stop |
| Cannot access ENVIROMUX through my browser | <ul style="list-style-type: none"> Browser not supported Trying to connect to wrong IP address User not authorized | <ul style="list-style-type: none"> See supported browsers on page 5 Type correct IP address into browser URL field. If IP address is unknown, use Discovery Tool (page 28) to identify it. See administrator for user name and password |
| Cannot access ENVIROMUX user interface with direct Ethernet connection | <ul style="list-style-type: none"> Telnet not enabled Cable not wired correctly | <ul style="list-style-type: none"> Must enable Telnet through web interface (page 81) Cable should be wired pin-to-pin (1 to 1, 2 to 2, etc.) |
| ENVIROMUX will not recognize sensor | Previously used sensor port was never cleared from memory upon removal | Click on “???” in summary page, click on “Configure “ button, click on “Remove” at bottom of Configure page to remove sensor and clear the port. (see page 39) |
| Device Discovery tool will not work | <ul style="list-style-type: none"> Java not installed PC and ENVIROMUX are on different physical networks | <ul style="list-style-type: none"> Download and install Java (see page 28) Make sure PC and ENVIROMUX or both on same physical network |
| Not receiving e-mail alert messages | <ul style="list-style-type: none"> Ethernet cable disconnected Wrong or no IP address provided for SMTP server User does not have user profile correctly configured Email address not accepted by SMTP server | <ul style="list-style-type: none"> Check Ethernet cable connections Check all Network Settings (page 81) Check user profile. Make sure groups have been selected and the contact settings are correct (see page 94) Check policies of SMTP server for restrictions |
| Beacon not illuminating | <ul style="list-style-type: none"> Wires are not connected properly Beacon in use is improperly rated Sensor is not configured to power-ON the beacon | <ul style="list-style-type: none"> Check wire connections Make sure Beacon is rated at 12VDC, 180mA or less Check sensor configuration- make sure Beacon is selected under “Alert Notifications” (-16D) |
| Siren not making noise | <ul style="list-style-type: none"> Wires are not connected properly Siren in use is improperly rated Sensor is not configured to power-ON the siren | <ul style="list-style-type: none"> Check wire connections Make sure Siren is rated at 12VDC, 180mA or less Check sensor configuration- make sure Siren is selected under “Alert Notifications” (-16D) |
| Ethernet cascading is not working | Ethernet Configuration not complete | <ul style="list-style-type: none"> Make sure the correct IP of the Slave unit is entered into the Master configuration Make sure Slave is configured as “Ethernet Slave” (page 111) If behind a firewall, make sure port 5919 is open for the ENVIROMUX to pass data through |

| Problem | Cause | Solution |
|--|--|--|
| The sensor page does not display the current readings | Java scripts cannot be displayed-java not enabled in browser | Enable the Java Scripts and Java in the browser |
| Sensor status alternates between “normal” and “no answer” on summary page

User is receiving alert notifications about sensors being disconnected and then reconnected | Electronic noise is being induced into sensor cables (near large motors, electronic ballasts, etc) causing errors in RS485 communication between ENVIROMUX and sensor. (this pertains to “RJ5 SENSORS” only) | Change the unshielded CATx cable to the RJ45 sensor(s) to shielded cable to reduce noise being introduced.

If the issue is ignored it could potentially lead to damage of the RS485 communication circuit and require the ENVIROMUX unit to be returned for repair |
| Sensors connected to RJ45 Sensor ports stop working | Sensors applied collectively exceed current rating. | Disconnect sensors. After approx. 10 minutes fuse inside ENVIROMUX should reset.
For E-16D: Make sure the load of all 8 sensors per row does not exceed 500 mA. (i.e. only one keypad per row (row 1 = ports 1-8, row 2= ports 9-16)) |
| Unit will not boot up-access via Ethernet not possible | Firmware has been corrupted | Contact NTI for FTP recovery software and procedure. |
| Sensor connected to DIGITAL IN terminal stops working (E-16D only) | Sensor is rated for more current than terminal can supply. Fuse protecting port has opened.

E-EDR-SF and E-EDR-SCR Electric Strike may cause this if connected to DIGITAL IN terminals 1-7 | Disconnect failed sensor. After approx. 10 minutes internal fuse should reset. Reconnect sensor to terminals provided sensor current requirements fall within terminal limitations.

DIGITAL IN terminals 1-7 max. load = 50mA
DIGITAL IN terminal 8 max. load = 350mA |
| Event Log has “GSM Error code -3” | GSM Modem failed to communicate with cell tower due to a weak signal | Adjust the modem antenna using the Enterprise Setup screen (page 77) as a guide for the best signal |
| Attempt at connection via HTTPS from outside the LAN errors out | Port in Firewall not open to secure connection to ENVIROMUX | Configure your firewall to allow communication through the port assigned to HTTPS connection (page 81). |
| Slave in cascaded configuration keeps losing communication with Master | Slave configured (within the web interface for the slave) to add sensor values to datalog. | Do not configure sensors from the Slave web interface, do not put a check in “Add to datalog” (page 43) and do not configure any alert methods. Only enable datalogging and alert methods for sensors when configuring them from the Master interface. |
| Mail server is rejecting email and the E-xD is logging Error code - 88. | bad data error | <ul style="list-style-type: none"> You have a user for whom email alerts are enabled but the email address is not valid The "from" email address is not valid. That is set in Administration -> Enterprise -> Email address OR in Network -> SMTP settings -> Username You have non ASCII characters either in Device name or location etc. <ul style="list-style-type: none"> You would have to select “HTML” format for these characters to be sent properly. |
| Internal humidity sensor measuring <30% humidity | Environment is dryer than it should be for optimal performance | Install a humidifier to raise humidity to between 30 and 50% for optimal performance of the server rack devices. |

SMTP Error Codes:

| Without SSL enabled: | Meaning | Comments |
|----------------------|--------------------------------|---|
| -1 | SMTP_CONN_ERR, | Cannot establish a connection to the SMTP server. Possible reasons: bad setting for IP of SMTP server, firewall blocking the connection |
| -4 | SMTP_SERVER_NOT_READY_ERR, | Server denied connection |
| -5 | SMTP_EHLO_ERR, | Server did not answer to HELO command |
| -6 | SMTP_AUTH_NO_SUPPORT_ERR, | Authentication method is not supported |
| -7 | SMTP_AUTH_FAILURE_ERR, | Authentication failure (user or password rejected) |
| -8 | SMTP_BAD_FROM_ERR, | SMTP Server did not accept the sender e-mail address |
| -9 | SMTP_BAD_TO_ERR, | SMTP Server did not accept the destination e-mail address |
| -10 | SMTP_DATA_ERR, | SMTP Server did not accept the DATA command |
| -11 | SMTP_BAD_DATA_ERR, | SMTP Server did not accept the body of e-mail message |
| With SSL enabled: | | |
| -100 | SMTP_SSL_CONN_ERR, | Failed to resolve connection to DNS server |
| -99 | SMTP_SSL_CONN_ERR1, | Cannot establish a connection to the SMTP server. Possible reasons: bad setting for IP of SMTP server, firewall blocking the connection |
| -98 | SMTP_SSL_CONN_ERR2, | System failed to create a socket (this is for internal reasons - like network down (a highly unlikely occurrence)) |
| -97 | SMTP_SSL_PROTOCOL_ERR, | SMTP server connected but did not accept SSL connection |
| -95 | SMTP_SSL_SERVER_NOT_READY_ERR, | Server denied connection |
| -94 | SMTP_SSL_EHLO_ERR, | Server did not answer to HELO command |
| -93 | SMTP_SSL_AUTH_NO_SUPPORT_ERR, | Authentication method is not supported |
| -92 | SMTP_SSL_AUTH_FAILURE_ERR, | Authentication failure (user or password rejected) |
| -91 | SMTP_SSL_BAD_FROM_ERR, | SMTP Server did not accept the sender e-mail address |
| -90 | SMTP_SSL_BAD_TO_ERR, | SMTP Server did not accept the destination e-mail address |
| -89 | SMTP_SSL_DATA_ERR, | SMTP Server did not accept the DATA command |
| -88 | SMTP_SSL_BAD_DATA_ERR, | -SMTP Server did not accept the body of e-mail message
-Invalid e-mail address in configuration |
| -87 | SMTP_TLS_ERROR, | Cannot connect through STARTTLS protocol. SMTP server probably does not support this protocol. Disable STARTTLS. |

Communication Ports used by the ENVIROMUX:

| Port Number | Purpose |
|-------------|--|
| 80 | HTTP (also IP sensor monitoring) |
| 443 | HTTPS |
| 22 | SSH |
| 23 | Telnet |
| 161 | SNMP (system config, sensor data and mgmt. software sensor data) |
| 162 | SNMP (traps) |
| 502 | MODBUS (default) |
| 514 | SYSLOG |
| 5908 | Sensor info for Management Software |
| 5919 | Cascading via Ethernet (disabled by default, to enable this see sman154-11.pdf) |
| 6000 | Management Software (to disable see page 90) |
| 6001 | SMS Relay Function (to disable see page 80) |

RS485 SENSORS

RS485 Sensors and Adapters used with the E-16D/5D/2D.

| NTI # | Description |
|--------------------|--|
| E-ACDCLM | AC & DC Voltage and Current Monitor |
| E-ACLM-3P480 | 3-Phase Power Monitor |
| E-ACLM-P-xx | AC Line Monitors |
| E-ACLM-V | AC Line Monitor |
| E-DCLM-6 | DC Voltage and Current Line Monitor |
| E-DI16DO16 | Digital Input/Output Expander |
| E-DI16DOR16 | Digital Input/Output Expander |
| E-PLSD | Programmable LED Sensor Display |
| E-S420MA-24V | Current Sensor Adapter |
| E-S5VDC | Voltage Sensor Adapter |
| E-S60VDC | Voltage Detector Converter |
| E-STHSM | Temperature/Humidity Sensor |
| E-STHSB | Temperature/Humidity Sensor |
| E-STSM | Temperature Sensor |
| E-STSMA | Temperature Sensor |
| E-STHS-LCDW | Temperature/Humidity Sensor W/ LCD |
| E-STHS-N4085IND-xx | Temp/Humidity Sensor |
| E-STSS | Temperature Sensor |
| E-STSS-O | Outdoor Temp Sensor-Cable Restraint Assembly |
| E-STSP-7 | Pipe Temperature Sensor |
| E-STSP-SL-7 | Pipe Temperature Sensor-Spring Loaded |
| E-STHS-PRC | Precision Temp Sensor |

BANDWIDTH USAGE

Common questions regarding network bandwidth usage for the E-xD unit:

- How much network bandwidth is needed for E-xD?
- How much network bandwidth is used between the E-xD unit and SNMP software?
- How can you configure the E-xD unit to use the least amount of network bandwidth?

The network bandwidth usage depends on a variety of factors like the number of sensors configured, polling rate of the management software, Syslog data logging if used, email alerts, frequency of alerts, browsers the web page is monitored with, etc.

With approximately 40 sensors of any kind configured per device, below are the data usage:

- Monitoring using sensor summary page: 350 KB per sensor page reload + 180KB every 60 sec
- Monitoring using individual sensor page: 350 KB per sensor page reload + 8KB every 60 sec
- Editing a sensor configuration: 300KB per edit
- 300 bytes for every alert email sent

Monitoring using ENVIROMUX Management software for a device with approximately 40 sensors:

- 16 KB every polling period (Default 5 seconds). Polling period is configurable in management software from 1 sec to 1 hour.
- 11 KB every device configuration load/reload from ENVIROMUX Management software server.

Monitoring using other management software using SNMP:

- When using SNMP v2 it takes 160 bytes per polling of a sensor
- With SNMP v3 it takes approximately 540 bytes per polling of a sensor.

So for 40 sensors with SNMPv2 at the rate of **60s scanning interval** (as set in a software like PRTG): 6.25KB per min

INDEX

- 3G data connection, 89
- 48VDC power option, 21
- AC adapter, 21
- acknowledge, 33, 39
- adding a sensor, 51
- Administration**, 72, 112
- alarm summary**, 36
- alarm test button, 121
- Alert Delay, 46
- Alert Notifications, 35, 46
- Alerts, 25
- alerts-enable, 36
- analog sensors, 38
- ASHRAE, 38
- audible alerts, 14
- battery backup, 121
- Cables required, 4
- connect sensors, 11
- Console connection**, 16
- Contact Sensors**, 51
- cycle sensor power, 56
- Data Logging, 26
- data log-view, 113
- ddns providers, 130
- default IP address, 29
- Device Discovery Tool, 28
- DHCP server, 81
- Digital In, 12
- Digital Input Sensors, 54
- Digital Out, 15
- Digital Output, 35, 46
- dismiss, 33, 39
- double-function sensor, 38
- downloads, 119
- Dual Power, 20
- email-customize, 76
- Enterprise Setup, 77
- error codes-SMTP, 134
- event log-view, 112
- Ext Alert, 6
- external sensor, 38
- firmware update-web, 110
- flash drive, 122
- Gmail settings, 84
- groups, 45
- GSM modem, 26, 77
- HTTP Server Port, 89
- Installation, 8
- Int Alert, 6
- internal sensors, 37
- IP Assignment, 25
- IP Cameras, 69
- IP Devices, 59
- IP filtering, 108
- Java Runtime Environment**, 28
- Language selection, 73
- LDAP mode, 102
- LDAP, User settings, 94
- LED Status Chart**, 120
- liquid detection sensor, 12
- log in, 29
- log settings, 116
- log to flashdrive, 118
- Low Batt, 6, 121
- maps configuration, 99
- mobile summary page, 123
- modem-serial, 18
- modem-**USB**, 18
- mounting, 9
- MQTT Settings, 87
- Network Page, 81
- Office 365 email, 85
- output relay**, 57, 76
- Password**, 29, 123
- port assignments, 130
- port number, 83, 89
- ports used, 134
- Power Supply Status, 33
- question marks, 38
- reboot, 111
- Remote Digital Inputs**, 54
- Remote Output Relay**, 57
- remote RS232 device, 23
- restore defaults button, 121
- RS485 sensors, 38, 135
- RSA key**, 75
- schedule settings, 47, 95
- security, 102
- sensor graphs-disable, 76
- Sensors, 25
- serial control, 122
- SMS alert messages, 18
- SMTP server, 81, 89
- SNMP, 26

| | |
|---------------------------------------|--------------------------------|
| S NMP-control outputs, 83 | Test Email Button, 81 |
| SNTP server, 72 | text menu-login, 122 |
| S ummary Page, 31 | threshold, 43, 46 |
| S upplemental Instructions, ii | U SB Flashdrive, 118 |
| Syslog, 26 | U SB port, 18, 122 |
| system configuration, 72 | user configuration, 92 |
| system information, 109 | User Management, 25 |
| system reset button, 120 | username and password, 29, 123 |
| Telnet, 16 | visual alerts, 14 |
| temperature/humidity sensors, 25 | X 509 certificate, 106 |

WARRANTY INFORMATION

The warranty period on this product (parts and labor) is two (2) years from the date of purchase. Please contact Network Technologies Inc at **(800) 742-8324** (800-RGB-TECH) or **(330) 562-7070** or visit our website at www.networktechinc.com for information regarding repairs and/or returns. A return authorization number is required for all repairs/returns.

MAN154 Rev. 3/12/26